

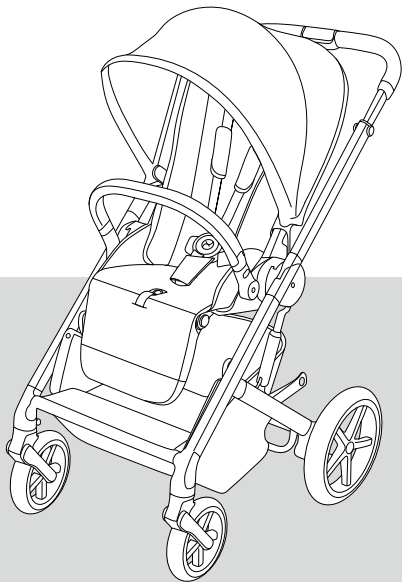

BALIOS S LUX





EN WARNING
DE WARNUNG
ES ADVERTENCIA
FR AVERTISSEMENT
PT AVISOS
IT ATTENZIONE
NL WAARSCHUWING
PL OSTRZEŻENIE
CS UPOZORNĚNÍ
SK UPOZORNENIE
SL OPOZORILO
HR UPOZORENJE
HU FIGYELMEZTETÉS
SE VARNING
NO ADVARSEL
FI VAROITUS
DA ADVARSEL
ET HOIATUS
LV BRĪDINĀJUMS
LT PERSPĖJIMAS
RU ВНИМАНИЕ
UK УВАГА
TR UYARI
EL ΠΡΟΕΙΔΟΠΟΙΗΣΗ
RO AVERTISMENTE
IS VIÐVÖRUN
MT TWISSIJA

AR
FA
YUE 警告
CMN 警告
JA 警告
KO 경고
BG ПРЕДУПРЕЖДЕНИЕ
SR UPOZORENJE
MS AMARAN
HI चेतावनी
TH คำเตือน
SQ PARALAJMËRIM
BS UPOZORENJE
ME UPOZORENJE
MK ПРЕДУПРЕДУВАЊЕ
HY շօղախոսություն
VI CẢNH BÁO

تحذير
اخطار



EN Tutorial video
DE Videoanleitung
ES Tutorial en vídeo
FR Vidéo de démonstration
PT Video tutorial
IT Video tutorial
NL Instructievideo
PL Film instruktażowy
CS Výukové video
SK Výukové video
SL Video z navodili
HR Video s uputama
HU Bemutatóvideó
SE Videosjälvstudiekurs
NO Opplæringsvideo
FI Opetusvideo
DA Vejledende video
ET Õppevideo
LV Ar mācību video
LT Mokomasis vaizdo įrašas
RU Обучающее видео
UK Навчальне відео
TR Öğretici video
EL Εκπαιδευτικό βίντεο
RO Video tutorial
IS Kennslumyndband
MT Tutorial fuq vidjow

AR
FA
YUE 教程視頻
CMN 教程视频
JA チュートリアルビデオ
KO 튜토리얼 동영상
BG Учебно видео
SR Video sa uputstvima
MS Video tutorial
HI ट्यूटोरियल वीडियो
TH วีดีโอแนะนำ
SQ Video udhëzuese
BS Video sa uputstvima
ME Video sa uputstvima
MK Видеоупатство
HY Παιδαγωγικά βίντεο
VI Video hướng dẫn

فیدویو تعلیمی
ویدئوی آموزشی

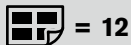

EN Maximum weights
DE Maximalgewichte
ES Pesos máximos
FR Poids maximum
PT Pesos máximos
IT Peso massimo
NL Maximumgewicht
PL Dopuszczalna waga
CS Maximální hmotnosti
SK Maximálne hmotnosti
SL Največje teže
HR Maksimalne težine
HU Maximális súlyok
SE Max.vikter
NO Maksimumsvektor
FI Enimmäispainot
DA Maksimumvægt
ET Maksimaalne kaal
LV Maksimālais svars
LT Didžiausi svoriai
RU Максимальная масса
UK Максимальна вага
TR Maksimum ağırlıklar

EL Μέγιστο βάρος
RO Greutăți maxime
IS Hámarksþyngd
MT Piżijiet massimi
AR الأوزان القصوى
FA حداکثر وزن
YUE 最大重量
CMN 最大重量
JA 最大重量
KO 최대 하중
BG Максимални тегла
SR Maksimalne težine
MS Berat maksimum
HI अधिकतम वजन
TH น้ำหนักสูงสุด
SQ Peshat maksimale
BS Maksimalne težine
ME Maksimalne težine
MK Максимални тежини
HY Առավելագույն քաշեր
VI Cáp mức cân nặng tối đa

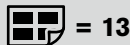

EN Product registration
DE Produktregistrierung
ES Registro del producto
FR Enregistrement du produit
PT Registo do produto
IT Registrazione del prodotto
NL Productregistratie
PL Rejestracja produktu
CS Registrace výrobku
SK Registrácia výrobku
SL Registracija izdelka
HR Registracija proizvoda
HU Termékregisztráció
SE Produktregistrering
NO Produktregistrering
FI Tuotteen rekisteröinti
DA Produktregistrering
ET Toote registreerimine
LV Produkta registrācija
LT Gaminio registracija
RU Регистрация продукта
UK Реєстрація продукту
TR Ürün kaydı

EL Καταχώριση προϊόντος
RO Înregistrarea produsului
IS Skráning tækis
MT Registrażjoni tal-prodott
AR تسجيل المنتج
FA ثبت محصول
YUE 產品註冊
CMN 产品注册
JA 製品の登録
KO 제품 등록
BG Регистрация на продукта
SR Registracija proizvoda
MS Pendaftaran produk
HI उत्पाद पंजीकरण
TH การลงทะเบียนผลิตภัณฑ์
SQ Regjistrimi i produktit
BS Registracija proizvoda
ME Registracija proizvoda
MK Регистрација на производ
HY Արտադրանքի գրանցում
VI Đăng ký sản phẩm

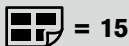

= 15

EN	Set up	EL	Στήσιμο
DE	Aufbau	RO	Setare
ES	Instalación	IS	Uppsetning
FR	Montage	MT	Konfigurazzjoni
PT	Preparação	AR	تنصيب
IT	Configurazione	FA	برپا کردن
NL	Opbouw	YUE	設置
PL	Montaż	CMN	设置
CS	Nastavení	JA	セットアップ
SK	Nastavenie	KO	설정
SL	Nastavitev	BG	Настройка
HR	Postavljanje	SR	Postavljanje
HU	Felszerelés	MS	Persediaan
SE	Inställning	HI	सेट अप
NO	Oppsett	TH	การติดตั้ง
FI	Asennus	SQ	Konfigurimi
DA	Opsætning	BS	Postavljanje
ET	Seadistamine	ME	Postavljanje
LV	Uzstādīšana	MK	Поставување
LT	Nuostatos	HY	Чորդաւորում
RU	Установка	VI	Cài đặt
UK	Встановлення		
TR	Kurulum		

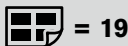

= 19

EN	Brake	EL	Φρένα
DE	Bremse	RO	Frână
ES	Freno	IS	Bremsa
FR	Frein	MT	Brejġ
PT	Bloqueio	AR	المكابح
IT	Freno	FA	ترمز
NL	Rem	YUE	剎車
PL	Hamulec	CMN	刹车
CS	Brzda	JA	ブレーキ
SK	Brzda	KO	브레이크
SL	Zavora	BG	Спирачка
HR	Kočnica	SR	Kočnica
HU	Fék	MS	Brek
SE	Broms	HI	ब्रेक
NO	Brems	TH	เบรค
FI	Jarru	SQ	Frenat
DA	Bremse	BS	Kočnica
ET	Pidur	ME	Kočnica
LV	Bremze	MK	Сопирачка
LT	Stabdys	HY	Սրբեխալ
RU	Тормоза	VI	Phanh thắng
UK	Гальма		
TR	Fren		

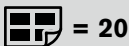

= 20

EN	Folding	EL	Αναδίπλωση
DE	Faltung	RO	Pliere
ES	Plegado	IS	Brjótá saman
FR	Pliant	MT	Tiwi
PT	Fecho	AR	
IT	Ripiegamento	FA	
NL	Vouwen	YUE	折疊
PL	Składanie	CMN	折疊
CS	Skládání	JA	折りたたみ
SK	Zloženie	KO	접기
SL	Zlaganje	BG	Сгъване
HR	Preklapanje	SR	Preklapanje
HU	Összecsukás	MS	Lipat
SE	Ihopfällning	HI	फोल्डिंग
NO	Sammenlegging	TH	การพับ
FI	Kokoon taittaminen	SQ	Palosja
DA	Sammenklapning	BS	Preklapanje
ET	Kokkuvoltimine	ME	Preklapanje
LV	Salocišana	MK	Склопување
LT	Lankstymas	HY	Ծալելը
RU	Складывание	VI	Gập lại
UK	Складання		
TR	Katlama		

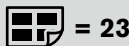
قابلية للطي
تاكردن

= 23

EN	Harness	EL	Συγκράτηση
DE	Gurtsystem	RO	Centură
ES	Arnés	IS	Beisli
FR	Harnais	MT	Ċinga tas-sigurtà
PT	Arnês	AR	طقم الشد
IT	Imbracatura	FA	سیدستم مهار
NL	Harnas	YUE	安全帶
PL	Szelki	CMN	安全帶
CS	Popruh	JA	安全ベルト
SK	Popruh	KO	하네스
SL	Varnostni pas	BG	Сбруя
HR	Sustav vezivanja	SR	Sistem vezivanja
HU	Biztonsági öv	MS	Abah-abah
SE	Sele	HI	कवच
NO	Beltesystem	TH	ระบบสายรัด
FI	Vyöjärjestelmä	SQ	Pajimet
DA	Selesystem	BS	Sistem vezivanja
ET	Turvarihmad	ME	Sistem vezivanja
LV	Drošības josta	MK	Сигурносен каиш
LT	Diržai	HY	Ամրազոսի
RU	Ремни безопасности	VI	Đay an toàn
UK	Ремінь		
TR	Emniyet kemeri		



 = 27

EN	Bumper bar	EL	Μπάρα διάταξης προστασίας
DE	Schutzbügel	RO	Bară de protecție
ES	Barra de seguridad	IS	Pverbiti
FR	Barre de protection	MT	Strixxa tal-bumper
PT	Barra de segurança	AR	عارضة ممتص الصدمات
IT	Barra paraurti	FA	میله ضربهگیر
NL	Veiligheidsbeugel	YUE	保險杠
PL	Pałak zabezpieczający	CMN	保險杠
CS	Dětské madlo	JA	バンパーバー
SK	Detská rúčka	KO	범퍼 바
SL	Varnostni lok	BG	Броня
HR	Štitnik	SR	Štitnik
HU	Karfa	MS	Bar bumper
SE	Stötfångare	HI	बम्पर बार
NO	Fender	TH	แถบกันชน
FI	Suojakaari	SQ	Shufra e parakolpit
DA	Sikkerhedsbøjle	BS	Štitnik
ET	Turvakaar	ME	Štitnik
LV	Aizsargloks	MK	Одбојник
LT	Amortizatoriaus strypas	HY	Թափարգել
RU	Поручень	VI	Thanh chống va đập
UK	Обмежувальний поручень		
TR	Tampon çubuğu		



 = 28

EN	Seat direction	EL	Κατεύθυνση καθίσματος
DE	Sitzrichtung	RO	Direcție scaun
ES	Dirección de la silla	IS	Sætisstefna
FR	Sens du siège	MT	Direzżjoni tas-sit
PT	Orientação do assento	AR	اتجاه المقعد
IT	Direzione di seduta	FA	جهت صندلی
NL	Zitrichting	YUE	座椅方向
PL	Kierunek siedzenia	CMN	座椅方向
CS	Směr sedadla	JA	シートの方向
SK	Smer sedadla	KO	좌석 방향
SL	Smer sedeža	BG	Посока на седалката
HR	Smjer sjedala	SR	Smer sedišta
HU	Úlésirány	MS	Arah kerusi
SE	Sitsriktning	HI	सीट दिशा
NO	Seteretning	TH	ทิศทางการที่นั่ง
FI	Istumasuunta	SQ	Drejtimi i ndenjësës
DA	Sæderetning	BS	Smjer sjedišta
ET	Istme suund	ME	Smjer sjedišta
LV	Sēdekļa virziens	MK	Правец на седиште
LT	Kėdutės kryptis	HY	Նստատեղի ուղղություն
RU	Направление сиденья	VI	Hướng ghế ngồi
UK	Напрямок сидіння		
TR	Koltuk yönü		



= 28

EN Backrest
DE Rückenlehne
ES Respaldo
FR Dossier
PT Encosto de costas
IT Schienale
NL Rugleuning
PL Oparcie
CS Opěradlo
SK Operadlo
SL Naslonjalo
HR Naslon
HU Háttámla
SE Ryggstöd
NO Rygglene
FI Selkänoja
DA Ryglæn
ET Seljatugi
LV Atzveltne
LT Nugaros atlošas
RU Спинка
UK Спинка
TR Arkalık

EL Πλάτη
RO Spătar
IS Bak
MT Serħ id-dahar
AR مسند الظهر
FA پشتی
YUE 靠背
CMN 靠背
JA 背もたれ
KO 등받이
BG Облегалка
SR Naslon
MS Penyangdar belakang
HI बैकरेस्ट
TH พนักพิง
SQ Mbështetësja e shpinës
BS Naslon
ME Naslon
MK Наслон за грб
HY Թիկնակ
VI Phần tựa lưng



= 29

EN Legrest
DE Beinstütze
ES Reposapiés
FR Repose-pieds
PT Apoio de pernas
IT Poggiagambe
NL Beensteun
PL Podnózek
CS Opěrka nohou
SK Opierka nôh
SL Naslon za noge
HR Naslon za noge
HU Lábtartó
SE Benstöd
NO Benstøtte
FI Jalkatuki
DA Benstøtte
ET Jalatugi
LV Kāju balsts
LT Kojų atrama
RU Подставка для ног
UK Опора для ніг
TR Bacak desteği

EL Στήριγμα ποδιών
RO Suport picior
IS Fótahvíla
MT Serħ is-saqajn
AR مسند الساق
FA جاپادی
YUE 腿托
CMN 腿托
JA 足のせ
KO 다리받이
BG Подложка за крака
SR Naslon za noge
MS Tempat letak kaki
HI लेगरेस्ट
TH ที่วางขา
SQ Mbështetësja e këmbëve
BS Naslon za noge
ME Naslon za noge
MK Наслон за нозе
HY Դստքերի հեւման կէտ
VI Phần tựa chân

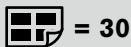

EN	Sun canopy	EL	Κουκούλα για τον ήλιο
DE	Sonnenverdeck	RO	Copertină
ES	Capota para el sol	IS	Sólartjald
FR	Pare-soleil	MT	Kopertura mix-xemx
PT	Capota solar	AR	مظلة الشمس
IT	Parasole	FA	سایبان
NL	Zonnekap	YUE	遮陽蓬
PL	Oslona przeciwsłoneczna	CMN	遮阳蓬
CS	Stříška proti slunci	JA	日よけ力パー
SK	Strieška proti slnku	KO	선 캐노피
SL	Senčnik za zaščito pred soncem	BG	Тента
HR	Tenda za sunce	SR	Tenda za sunce
HU	Kupola	MS	Kanopi matahari
SE	Solsufflett	HI	धूप छतरी
NO	Solskjerm	TH	หลังคาบังแดด
FI	Aurinkokatot	SQ	Strea për diellin
DA	Solkaleche	BS	Tenda za sunce
ET	Päikesevari	ME	Tenda za sunce
LV	Saules aizsegs	MK	Стреа за сонце
LT	Stogelis nuo saulės	HY	Արևապաշտպան ծածկ
RU	Солнцезащитный козырек	VI	Mái che nắng
UK	Тент від сонця		
TR	Güneş başlığı		

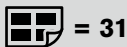

EN	Handle bar	EL	Ράβρος λαβής
DE	Schiebegriff	RO	Mâner
ES	Manillar	IS	Handfang
FR	Poignée de poussée	MT	Handle bar
PT	Guiador	AR	عارضضة المقبض
IT	Manubrio	FA	میلہ دستہ
NL	Duwstang	YUE	把手
PL	Uchwyt	CMN	把手
CS	Madlo	JA	ハンドルバー
SK	Rukoväť	KO	핸들 바
SL	Ročaj	BG	Кормило
HR	Ručice	SR	Ručke
HU	Tolókar	MS	Bar pemegang
SE	Handtag	HI	हैंडल बार
NO	Håndtak	TH	ด้ามจับ
FI	Työntökahva	SQ	Shufra e dorezës
DA	Styr	BS	Ručice
ET	Sang	ME	Ručke
LV	Rokturis	MK	Рачка
LT	Rankena	HY	Կարալվարման բռնակ
RU	Рукоятка	VI	Tay càm
UK	Рукоятка		
TR	Tutma sapı		

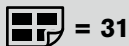

EN Swivel locks	EL Περιστρεφόμενες κλειδαριές
DE Schwenkradsperre	RO Încuietori pivotante
ES Bloqueos de dirección	IS Snúningslásar
FR Verrous pivotants	MT Lokks li jduru
PT Bloqueios de rotação	AR أقفال دوران العجلات
IT Blocchi girevoli	FA قفل‌های دوسان
NL Zwenkvergrendeling	YUE 旋轉鎖
PL Blokada obrotu	CMN 旋转锁
CS Aretační zámky	JA 回転口ツク
SK Aretačné zámky	KO 회전 잠금장치
SL Blokada vrtenja	BG Завъртащи се ключалки
HR Zaključavanje okretanja	SR Zakretni mehanizmi
HU Beállás-zár	MS Kunci ayun
SE Vridlås	HI कुंडा ताले
NO Svingelåser	TH ตัวล็อกแบบหมุน
FI Kääntölukko	SQ Kucja e rrotave
DA Drejelås	BS Zakretni mehanizmi
ET Pöördlukustus	ME Zakretni mehanizmi
LV Rotācijas bloķētāji	MK Заклучување на тркалата
LT Šarnyriniai fiksatoriai	HY Դիտույտի կողպիչներ
RU Блокировки вращения	VI Khóa xoay
UK Замок шарніра	
TR Tekerlek kilidi	

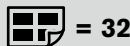

EN Removing the wheels	EL Αφαίρεση των τροχών
DE Entfernen der Räder	RO Îndepărtarea roților
ES Quitar las ruedas	IS Fjarlægja hjól
FR Retrait des roues	MT Tneħhija tar-roti
PT Remover as rodas	AR فك العجلات
IT Rimozione delle ruote	FA باز کردن چرخ‌ها
NL De wielen verwijderen	YUE 拆卸車輪
PL Zdejmowanie kółek	CMN 拆卸车轮
CS Odstranění koleček	JA 車輪の取り外し
SK Odstránenie koliesok	KO 휠 제거
SL Odstranjevanje koles	BG Демонтиране на колелата
HR Uklanjanje kotača	SR Uklanjanje točkova
HU Kerekek eltávolítása	MS Menanggalkan roda
SE Ta bort hjulen	HI पहियों को हटाना
NO Fjerne hjulene	TH การถอดล้อ
FI Pyörien poisto	SQ Heqja e rrotave
DA Fjernelse af hjulene	BS Uklanjanje točkova
ET Rataste eemaldamine	ME Uklanjanje točkova
LV Riteņu atvienošana	MK Отстранување на тркалата
LT Ratų nuėmimas	HY Արկվերըը հանելը
RU Снятие колес	VI Tháo bánh xe
UK Зняття коліс	
TR Tekerlekleri çıkarma	



= 33

EN	Removing the fabric	EL	Αφαίρεση του υφάσματος
DE	Entfernen des Bezuges	RO	Îndepărtarea țesăturii
ES	Quitar la tela	IS	Fjarlægja efni
FR	Retrait du tissu	MT	Tneħħija tad-drapp
PT	Remover o tecido	AR	فك القماش
IT	Rimozione del tessuto	FA	برداشتن پارچه
NL	De stof verwijderen	YUE	拆除罩布
PL	Zdejmowanie pokrycia	CMN	拆除罩布
CS	Odstranění látky	JA	カバーの取り外し
SK	Odstránenie látky	KO	페브릭 제거
SL	Odstranjevanje blaga	BG	Демонтиране на плата
HR	Uklanjanje tkanine	SR	Uklanjanje tkanine
HU	Huzat eltávolítása	MS	Menanggalkan fabrik
SE	Ta bort tyget	HI	कपड़ा हटाना
NO	Fjerne stoffet	TH	การถอดผ้า
FI	Kankaan poisto	SQ	Heqja e copës
DA	Fjernelse af stoffet	BS	Uklanjanje tkanine
ET	Kanga eemaldamine	ME	Uklanjanje tkanine
LV	Pārklājuma atvienošana	MK	Отстранување на навлакмата
LT	Audinio nuėmimas	HY	Գործվածքը հանելը
RU	Снятие ткани	VI	Tháo phần vải bọc
UK	Зняття матерії		
TR	Kılıfı çıkarma		



= 42

EN	Rain cover	EL	Καλύπτρα βροχής
DE	Regenverdeck	RO	Prelată de ploaie
ES	Funda para la lluvia	IS	Regn yfirbreiðsla
FR	Housse de pluie	MT	Għata mix-xita
PT	Capa de chuva	AR	غطاء المطر
IT	Parapioggia	FA	روکش باران
NL	Regenhoes	YUE	防雨罩
PL	Oslona od deszczu	CMN	防雨罩
CS	Pláštěnka	JA	雨よけ
SK	Kryt proti dažďu	KO	레인커버
SL	Dežna prevleka	BG	Дъждобран
HR	Pokrivač za kišu	SR	Pokrivač za kišu
HU	Esővédő	MS	Pelindung hujan
SE	Regnskydd	HI	रेन कवर
NO	Kalesje	TH	ผ้าคลุมกันฝน
FI	Sadesuoja	SQ	Mbulesë për shiun
DA	Regnslag	BS	Pokrivač za kišu
ET	Vihmakate	ME	Pokrivač za kišu
LV	Pretlietus pārvalks	MK	Прекривка за дожд
LT	Uždangalas nuo lietaus	HY	Անձրևապաշտպակ ծածկ
RU	Дождевик	VI	Tấm che mưa
UK	Дошовик		
TR	Yağmurluk		

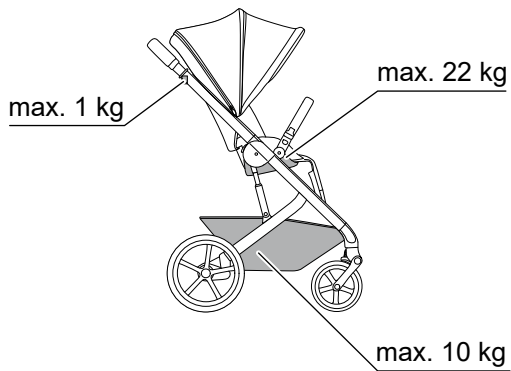



a

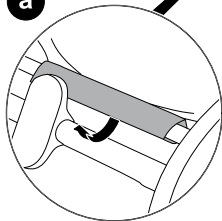

b

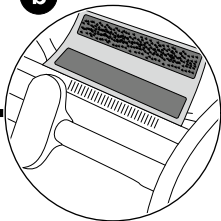

c

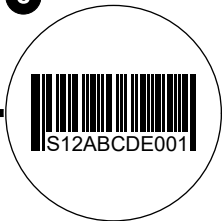

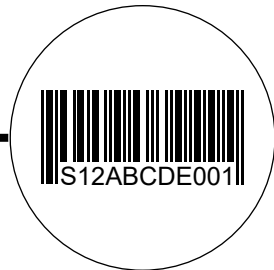
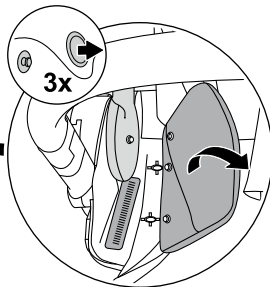
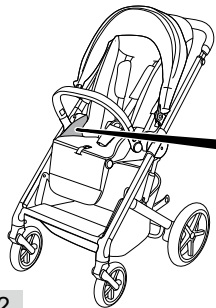

2

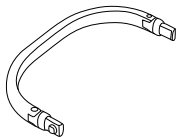
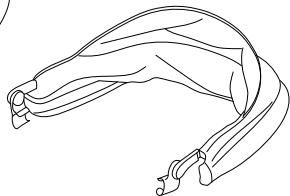
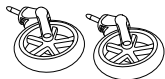
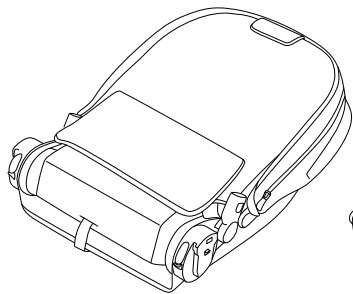
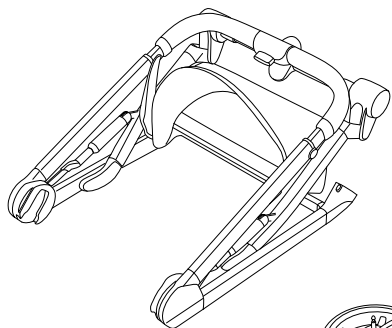

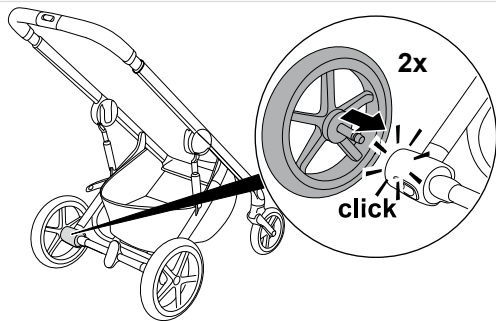

2

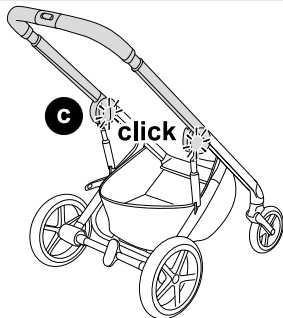
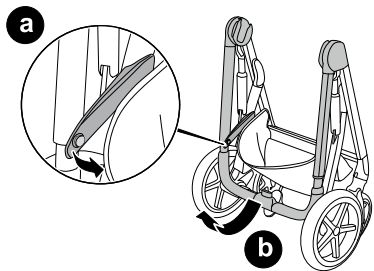

3

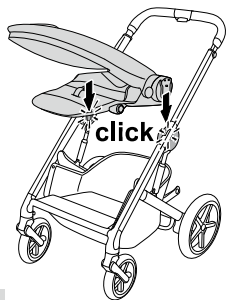

4

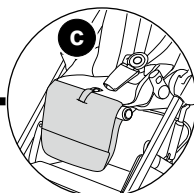
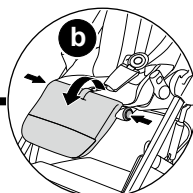

5

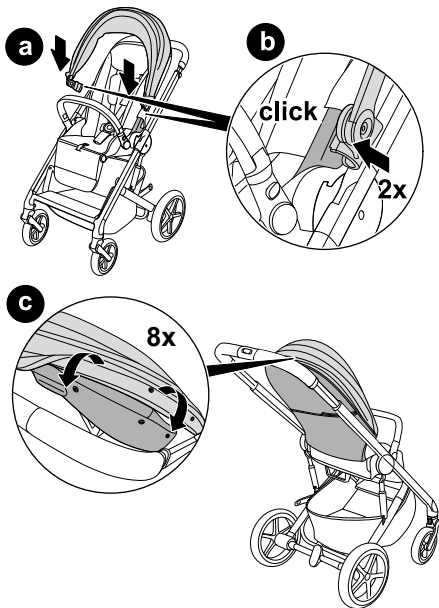
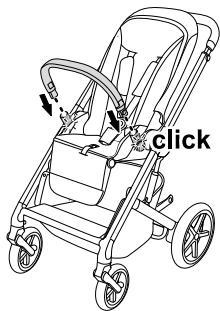

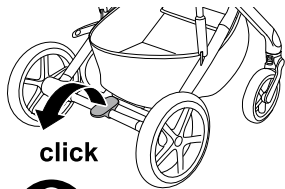

click

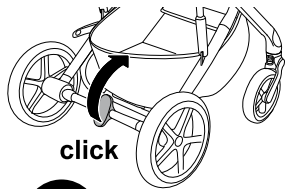

click



1



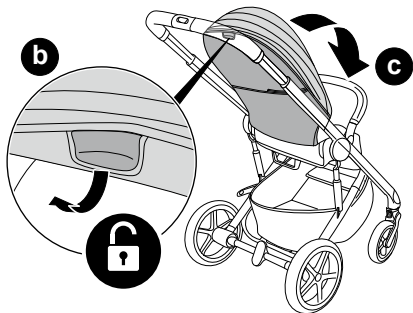
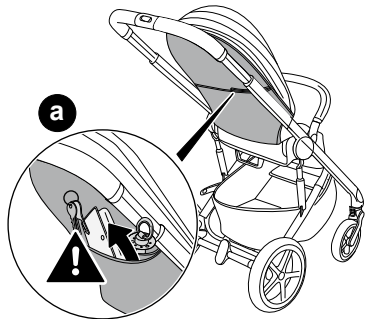

c



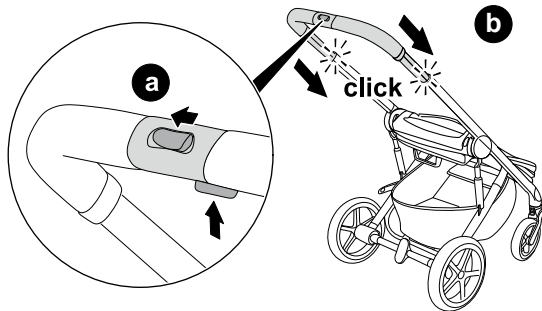

2

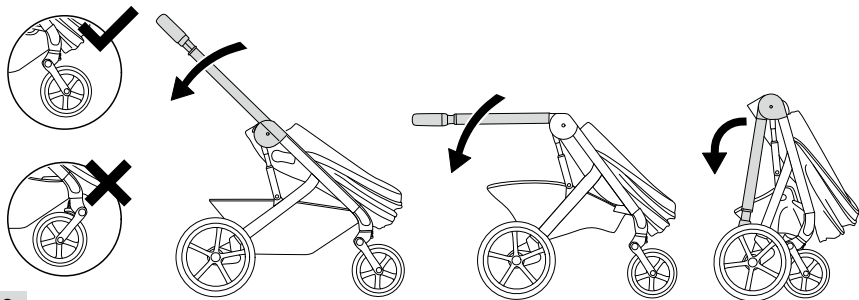

3

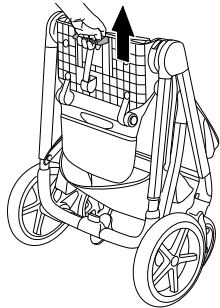
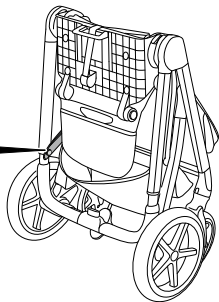
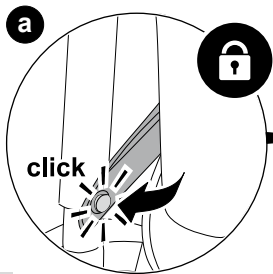

4

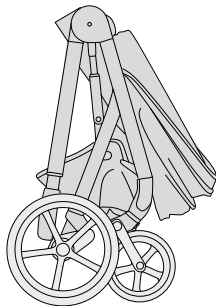

5

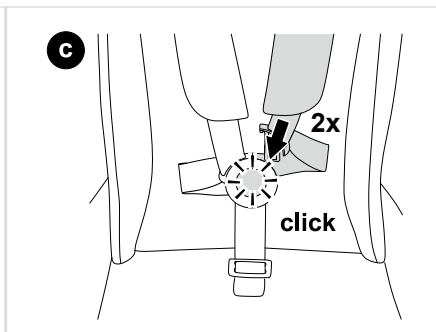
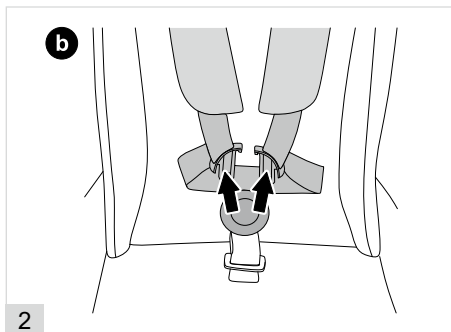
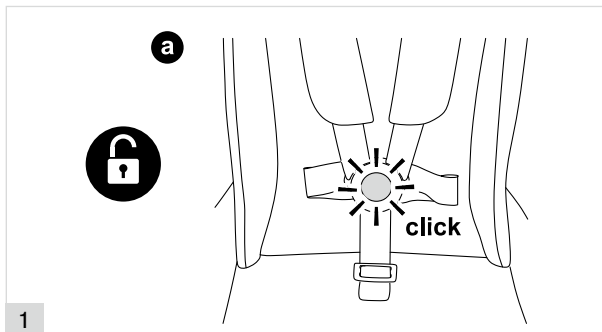



d

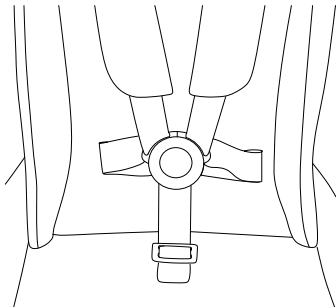

3

a

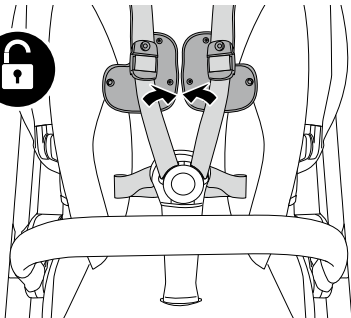

b

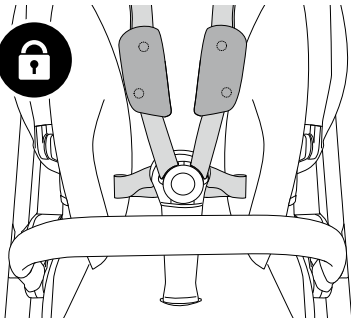

4

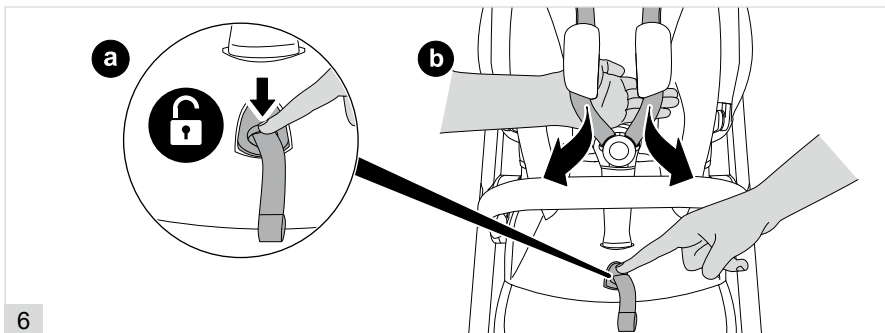
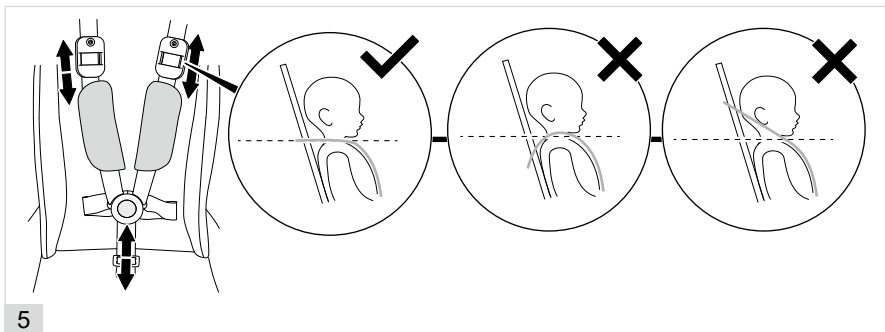

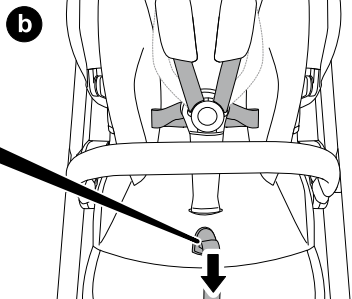
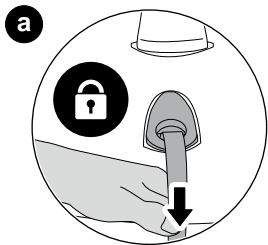

7

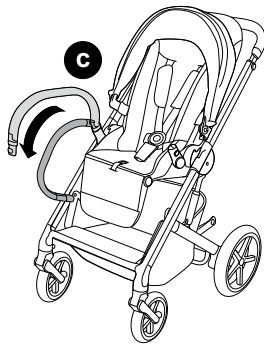
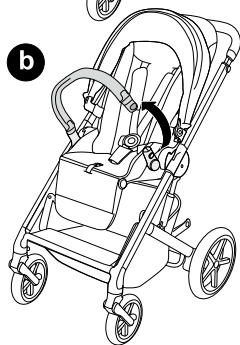
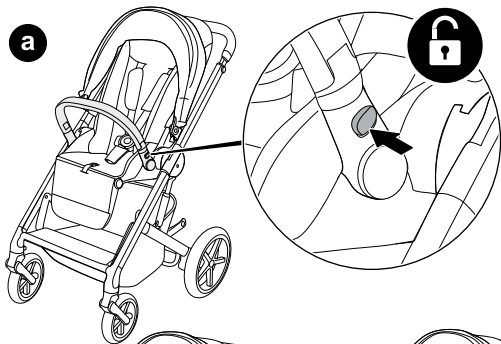

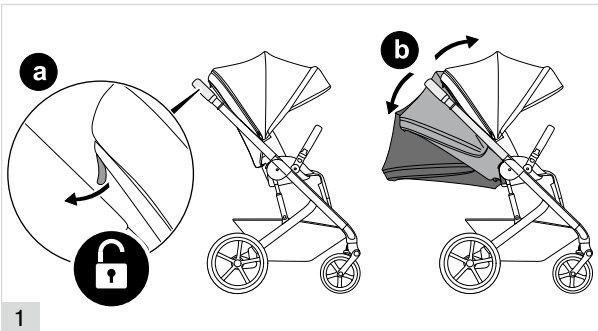
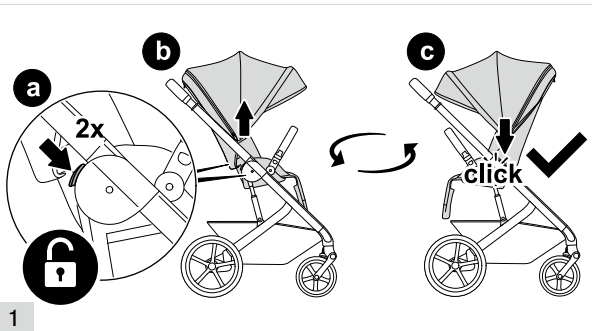

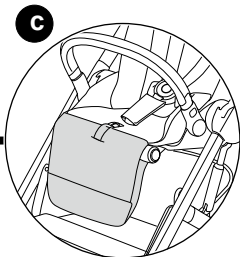
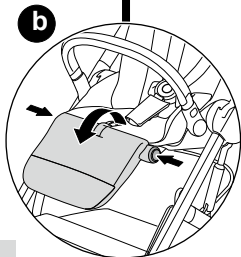
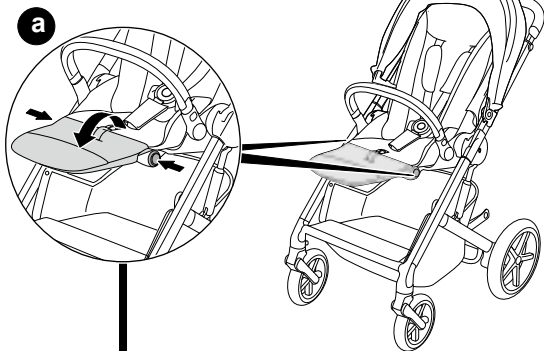

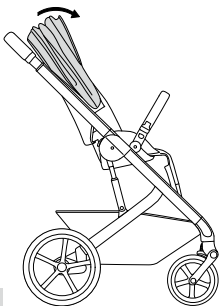

1

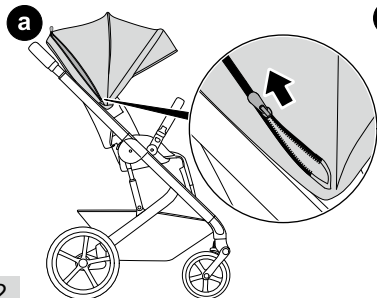
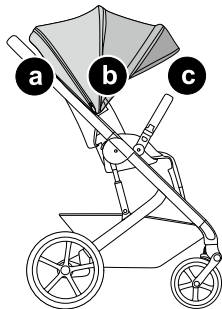

2

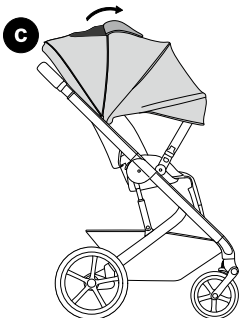
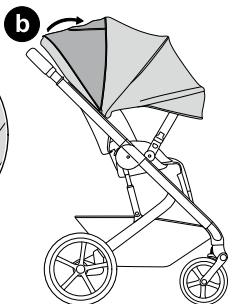

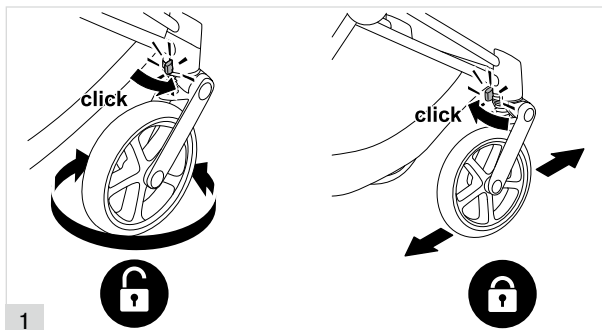
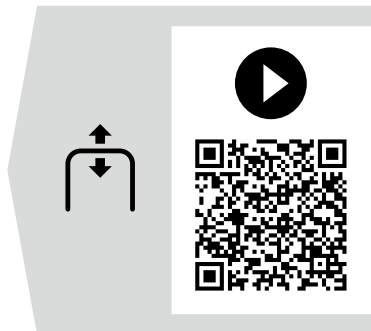
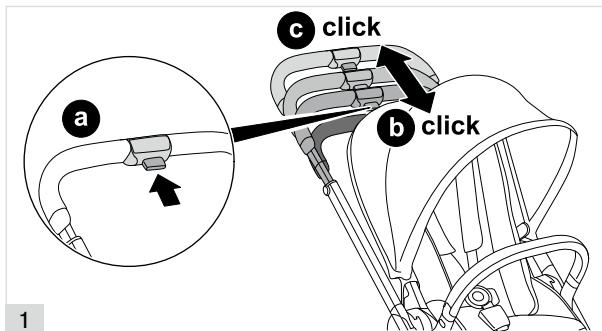

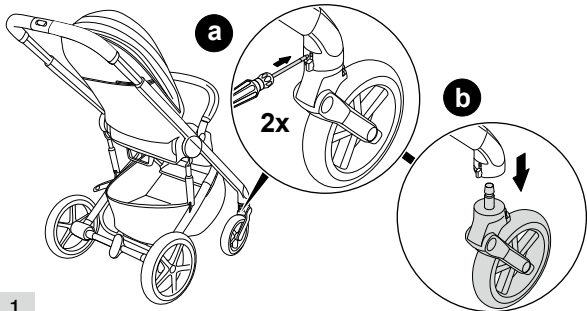

1

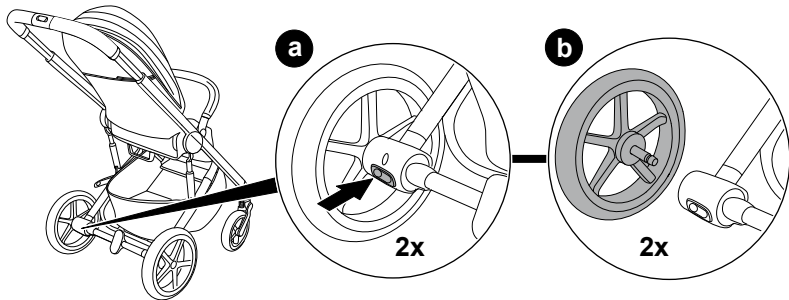

2

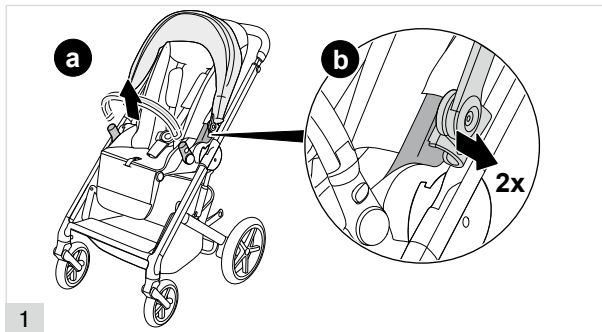

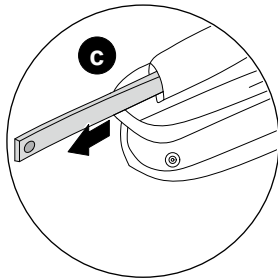
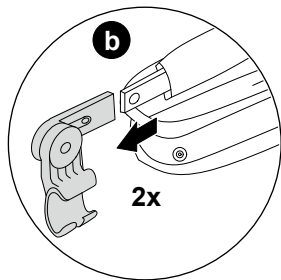
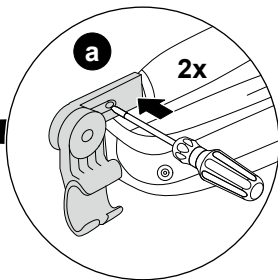
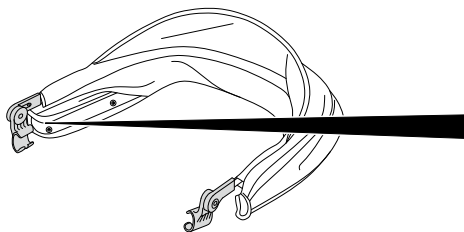

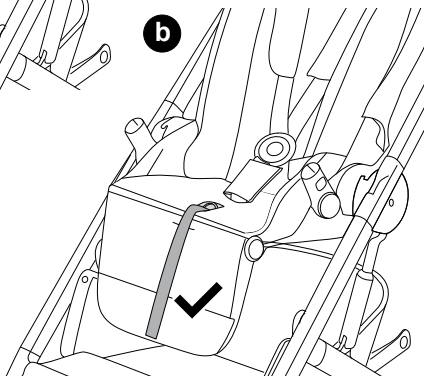
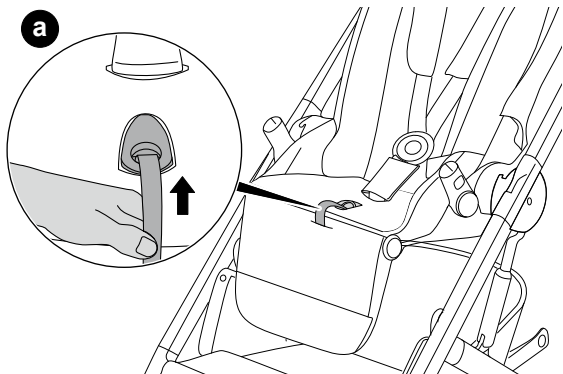

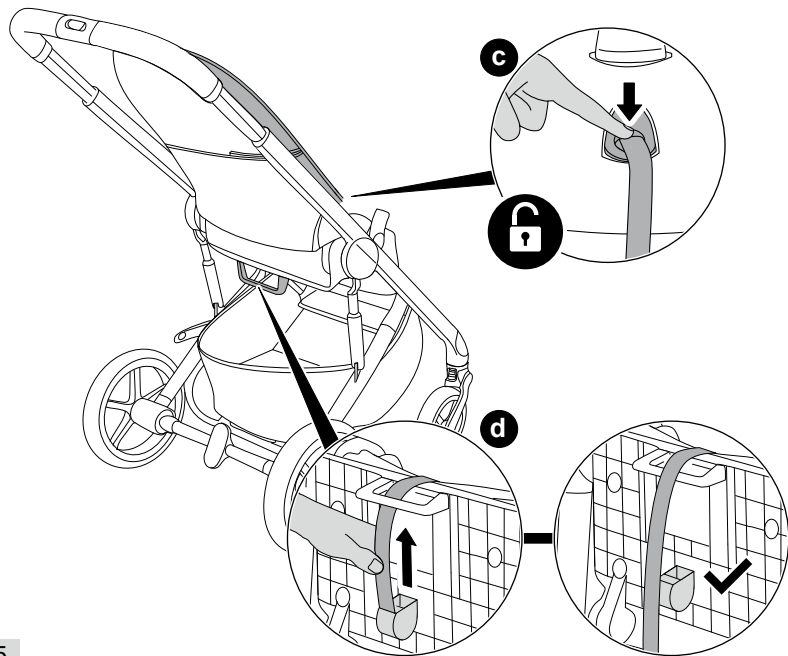

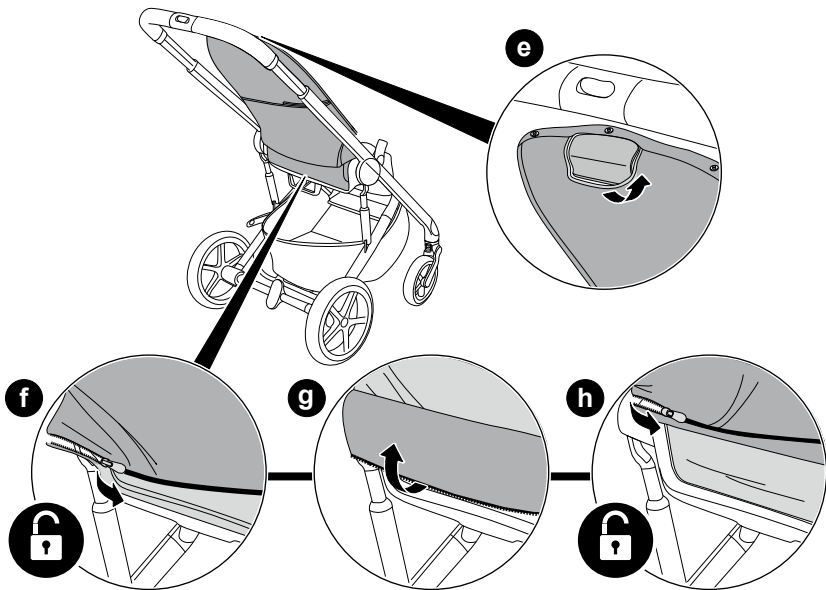



a

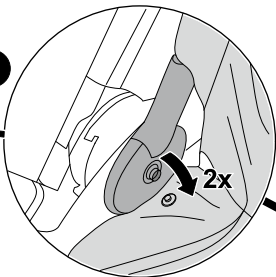

b

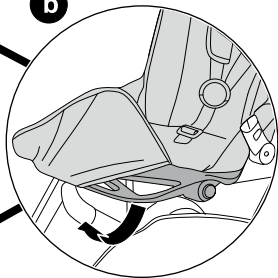

d



c

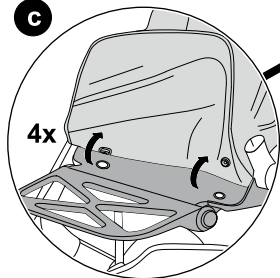

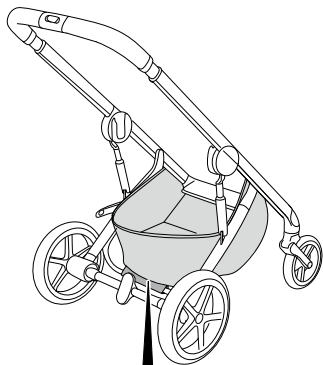

a

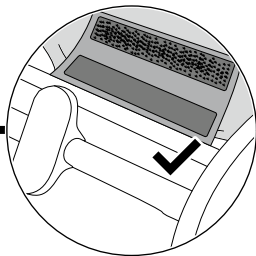
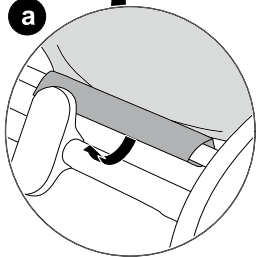

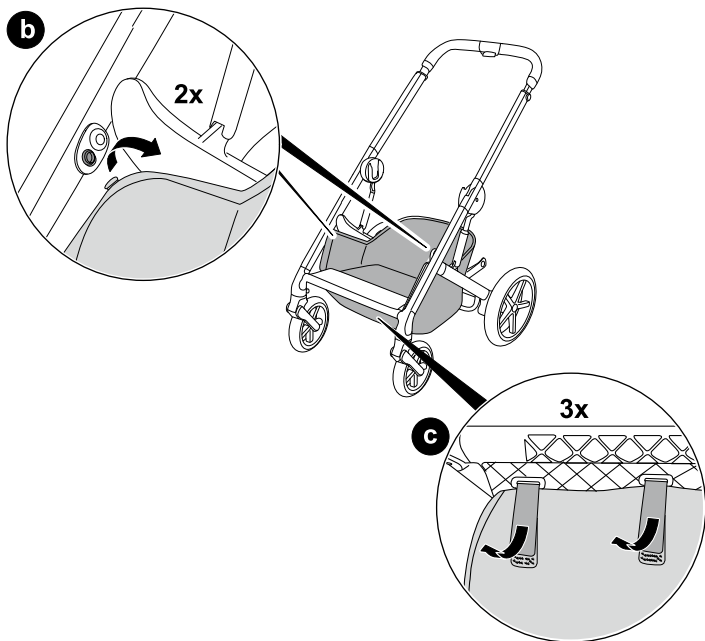

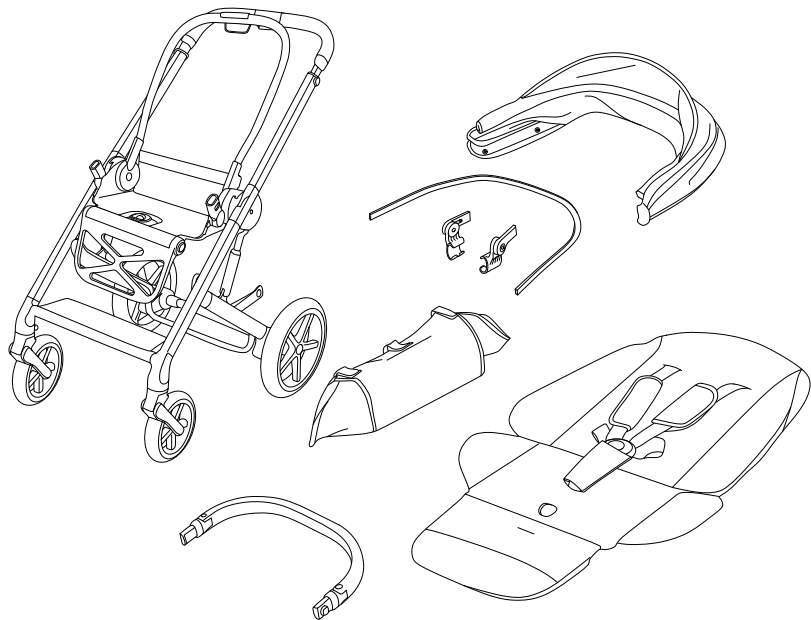

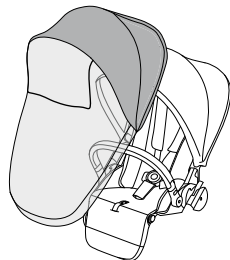

1

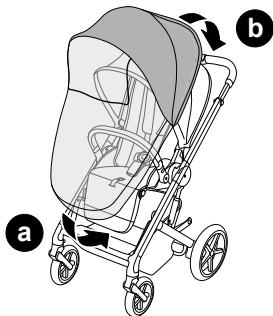



CYBEX GmbH

Riedingerstr. 18 | 95448 Bayreuth | Germany
+49 (0) 921-78 511-0 | info@cybex-online.com

www.cybex-online.com

