

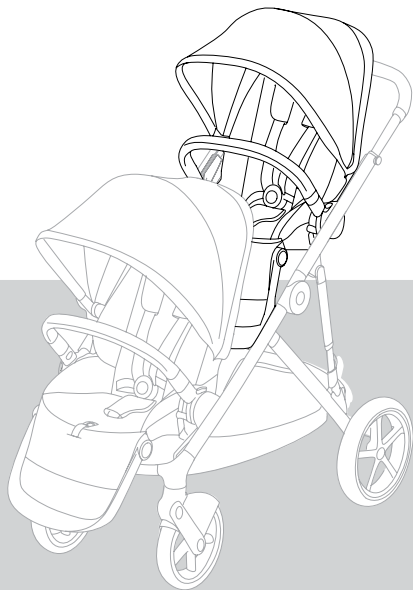

GAZELLE S SEAT UNIT





EN WARNING
DE WARNUNG
ES ADVERTENCIA
FR AVERTISSEMENT
PT AVISOS
IT ATTENZIONE
NL WAARSCHUWING
PL OSTRZEŻENIE
CS UPOZORNĚNÍ
SK UPOZORNENIE
SL OPOZORILO
HR UPOZORENJE
HU FIGYELMEZTETÉS
SE VARNING
NO ADVARSEL
FI VAROITUS
DA ADVARSEL
ET HOIATUS
LV BRĪDINĀJUMS
LT PERSPĖJIMAS
RU ВНИМАНИЕ
UK УВАГА
TR UYARI
EL ΠΡΟΕΙΔΟΠΟΙΗΣΗ
RO AVERTISMENTE
IS VIÐVÖRUN
MT TWISSIJA

AR
FA
YUE 警告
CMN 警告
JA 警告
KO 경고
BG ПРЕДУПРЕЖДЕНИЕ
SR UPOZORENJE
MS AMARAN
HI चेतावनी
TH คำเตือน
SQ PARALAJMËRIM
BS UPOZORENJE
ME UPOZORENJE
MK ПРЕДУПРЕДУВАЊЕ
HY ՉԳՈՒՇԱՑՈՒՄ
VI CẢNH BÁO

تحذير
اخطار



EN Tutorial video
DE Videoanleitung
ES Tutorial en vídeo
FR Vidéo de démonstration
PT Video tutorial
IT Video tutorial
NL Instructievideo
PL Film instruktażowy
CS Výchovné video
SK Výchovné video
SL Video z navodili
HR Video s uputama
HU Bemutatóvideó
SE Videosjälvstudiekurs
NO Opplæringsvideo
FI Opetusvideo
DA Vejledende video
ET Õppevideo
LV Ar mācību video
LT Mokomasis vaizdo įrašas
RU Обучающее видео
UK Навчальне відео
TR Öğretici video
EL Εκπαιδευτικό βίντεο
RO Video tutorial
IS Kennslumyndband
MT Tutorial fuq vidjow

AR
FA
YUE 教程視頻
CMN 教程视频
JA チュートリアルビデオ
KO 튜토리얼 동영상
BG Учебно видео
SR Video sa uputstvima
MS Video tutorial
HI क्यूटोरियल वीडियो
TH วิทยาลัยออนไลน์
SQ Video udhëzuese
BS Video sa uputstvima
ME Video sa uputstvima
MK Видеоупатство
HY Παιδαγωγικά βίντεο
VI Video hướng dẫn

فيديو تعليمي
ويدئوى آموزشى



EN Configurations
DE Konfigurationen
ES Configuraciones
FR Configurations
PT Configurações
IT Configurazione
NL Configuraties
PL Konfiguracje
CS Konfigurace
SK Konfigurácie
SL Konfiguracije
HR Konfiguracije
HU Konfigurációk
SE Konfigurationer
NO Konfigurasjoner
FI Määrittelyt
DA Konfigurationer
ET Konfiguratsioonid
LV Konfigurācija
LT Konfigūracijos
RU Конфигурации
UK Конфігурації

TR Kurulum Şekilleri
EL Ρυθμίσεις
RO Configurații
IS Stillingar
MT Konfigurazzjonijiet
AR الإعدادات
FA پیکربندیها
YUE 配置
CMN 配置
JA 構成
KO 구성
BG Конфигурации
SR Konfiguracije
MS Konfigurasi
HI कॉन्फिगरेशन
TH การกำหนดค่า
SQ Konfigurimet
BS Konfiguracije
ME Konfiguracije
MK Конфигурации
HY Կոնֆիգուրացիոն
VI Thông số cấu hình

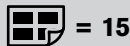

EN Maximum weights
DE Maximalgewichte
ES Pesos máximos
FR Poids maximum
PT Pesos máximos
IT Peso massimo
NL Maximumgewicht
PL Dopuszczalna waga
CS Maximální hmotnosti
SK Maximálne hmotnosti
SL Največje teže
HR Maksimalne težine
HU Maximális súlyok
SE Max.vikter
NO Maksimumsvekt
FI Enimmäispainot
DA Maksimumvægt
ET Maksimaalne kaal
LV Maksimālais svars
LT Didžiausi svoriai
RU Максимальная масса
UK Максимальна вага

TR Maksimum ağırlıklar
EL Μέγιστο βάρος
RO Greutăți maxime
IS Hámarksþyngd
MT Pizżijiet massimi
AR الأوزان القصوى
FA حداکثر وزن
YUE 最大重量
CMN 最大重量
JA 最大重量
KO 최대 하중
BG Максимални тегла
SR Maksimalne težine
MS Berat maksimum
HI अधिकतम वजन
TH น้ำหนักสูงสุด
SQ Peshat maksimale
BS Maksimalne težine
ME Maksimalne težine
MK Максимални тежини
HY Առավելագույն զանգված
VI Các mức cân nặng tối đa



= 16

EN	Product registration	TR	Ürün kaydı
DE	Produktregistrierung	EL	Καταχώριση προϊόντος
ES	Registro del producto	RO	Înregistrarea produsului
FR	Enregistrement du produit	IS	Skráning tækis
PT	Registo do produto	MT	Reġistrazzjoni tal-prodott
IT	Registrazione del prodotto	AR	تسجيل المنتج
NL	Productregistratie	FA	ثبت محصول
PL	Rejestracja produktu	YUE	產品註冊
CS	Registrace výrobku	CMN	产品注册
SK	Registrácia výrobku	JA	製品の登録
SL	Registracija izdelka	KO	제품 등록
HR	Registracija proizvoda	BG	Регистрация на продукта
HU	Termékregisztráció	SR	Registracija proizvoda
SE	Produktregistrering	MS	Pendaftaran produk
NO	Produktregistrering	HI	उत्पाद पंजीकरण
FI	Tuotteen rekisteröinti	TH	การลงทะเบียนผลิตภัณฑ์
DA	Produktregistrering	SQ	Regjistrimi i produktit
ET	Toote registreerimine	BS	Registracija proizvoda
LV	Produkta registrācija	ME	Registracija proizvoda
LT	Gaminio registracija	MK	Регистрација на производ
RU	Регистрация продукта	HY	Ապրանքի գրանցում
UK	Реєстрація продукту	VI	Đăng ký sản phẩm



= 17

EN	Set up	TR	Kurulum
DE	Aufbau	EL	Στήσιμο
ES	Instalación	RO	Setare
FR	Montage	IS	Uppsetning
PT	Preparação	MT	Konfigurazzjoni
IT	Configurazione	AR	تنصيب
NL	Opbouw	FA	برپا کردن
PL	Montaż	YUE	設置
CS	Nastavení	CMN	设置
SK	Nastavenie	JA	セットアップ
SL	Nastavitev	KO	설정
HR	Postavljanje	BG	Настройка
HU	Felszerelés	SR	Postavljanje
SE	Inställning	MS	Persediaan
NO	Oppsett	HI	सेट अप
FI	Asennus	TH	การติดตั้ง
DA	Opsætning	SQ	Konfigurimi
ET	Seadistamine	BS	Postavljanje
LV	Uzstādīšana	ME	Postavljanje
LT	Nuostatos	MK	Поставување
RU	Установка	HY	Շարժավորում
UK	Встановлення	VI	Cài đặt

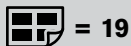

EN	Adjusting seat adapter	ET	Istme adapteri reguleerimine	SR	Podešavanje adaptera sedišta	BS	Podešavanje adaptera sjedišta
DE	Einstellung des Sitzadapters	LV	Sēdekļa adaptera regulēšana	MS	Melaraskan penyesuai tempat duduk	ME	Podešavanje adaptera sjedišta
ES	Ajuste del adaptador del asiento	LT	Kėdutės adapterio reguliavimas	HI	सीट एडॉप्टर समायोजित करना	MK	Приспособување на адаптерот за седиште
FR	Régler l'adaptateur de siège	RU	Регулировка адаптера кресла	TH	การปรับอะแดปเตอร์ที่นั่ง	HY	Նստատեղի ադապտերի հարմարեցում
PT	Ajuste do adaptador de assento	UK	Регулювання адаптера крісла	SQ	Përdorimi i adaptorit të sexholinos	VI	Điều chỉnh bộ phận điều hợp ghế ngồi
IT	Regolazione dell'adattatore del seggiolino	TR	Koltuk adaptörünün ayarlanması				
NL	De adapter van het autostoeltje aanpassen	EL	Προσαρμογή του αντάπτορα καθίσματος				
PL	Dostosowywanie adaptera fotelika	RO	Reglarea adaptorului scaunului				
CS	Nastavení adaptéru sedadla	IS	Stilla sætismillistykki				
SK	Nastavenie adaptéra sedadla	MT	Kif taġġuġta l-adapter tas-sedil				
SL	Prilaganje adapterja za sedež	AR	تعديل محول المقعد				
HR	Podešavanje adaptera sjedala	FA	تنظیم آداپتور صندلی				
HU	Az ülésadapter beállítás	YUE	調節座椅適配器				
SE	Justera sitsadaptern	CMN	调节座椅适配器				
NO	Justering av seteadapter	JA	シート調節アダプター				
FI	Istuimen säätöadapteri	KO	시트 어댑터 조정하기				
DA	Indstilling af sædeadapteren	BG	Регулиране на адап				

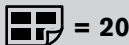

EN	Using the DUO Stroller	ET	Käru DUO kasutamine	MS	Menggunakan kereta sorong DUO	ME	Korišćenje DUO dječjih kolica
DE	Verwendung des DUO-Kinderwagens	LV	DUO bērnu ratiņu izmantošana	HI	DUO स्ट्रोलर का उपयोग करना	MK	Како да ја користите количната DUO
ES	Uso del cochecito DUO	LT	Vežimėlio DUO naudojimas	TH	การใช้งานรถเข็นเด็ก DUO	HY	DUO սայլակի օգտագործումը
FR	Utiliser la poussette DUO	RU	Использование детской коляски DUO	SQ	Përdorimi i karrocës DUO	VI	Sử dụng xe đẩy DUO
PT	Utilização do carrinho DUO	UK	Користування коляскою DUO				
IT	Uso del passeggino DUO	TR	DUO bebek arabasının kullanımı				
NL	De DUO wandelwagen gebruiken	EL	Χρήση του καροτσιού DUO				
PL	Używanie wózka DUO	RO	Utilizarea căruciorului DUO				
CS	Používání kočárku DUO	IS	Að nota DUO kerru				
SK	Používanie kočíka DUO	MT	Kif tuża l-istroller DUO				
SL	Uporaba otroškega vozička DUO	AR	استخدام عربة الأطفال الثنائية				
HR	Korištenje DUO dječjih kolica	FA	استفاده از کالسکه DUO				
HU	A DUO babakocsi használata	YUE	使用 DUO 嬰兒車				
SE	Använda sittvagnen DUO	CMN	使用 DUO 婴儿车				
NO	Bruk av DUO barnevognen	JA	ベビーカーDUOの使用 方法				
FI	DUO-rattaiden käyttö	KO	DUO 유모차 사용하기				
DA	Sådan anvendes DUO-klapvognen	BG	Използване на детската количка DUO				
ET	Käru DUO kasutamine	SR	Korišćenje DUO dečjih kolica				



 = 23

EN	Folding	TR	Katlama
DE	Faltung	EL	Αναδίπλωση
ES	Plegado	RO	Pliere
FR	Pliant	IS	Brjóta saman
PT	Fecho	MT	Tiwi
IT	Ripiegamento	AR	
NL	Vouwen	FA	
PL	Składanie	YUE	折疊
CS	Skládání	CMN	折疊
SK	Zloženie	JA	折りたたみ
SL	Zlaganje	KO	접기
HR	Preklapanje	BG	Сгъване
HU	Összecsukás	SR	Preklapanje
SE	Ihopfällning	MS	Lipat
NO	Sammenlegging	HI	फोल्डिंग
FI	Kokoon taittaminen	TH	การพับ
DA	Sammenklapning	SQ	Palosja
ET	Kokkuvoltimine	BS	Preklapanje
LV	Salocīšana	ME	Preklapanje
LT	Lankstymas	MK	Склопување
RU	Складывание	HY	Ծախելը
UK	Складання	VI	Gập lại

قابلية للطي
تا کردن



 = 26

EN	Harness	TR	Emniyet kemeri
DE	Gurtsystem	EL	Συγκράτηση
ES	Arnés	RO	Centură
FR	Harnais	IS	Beisli
PT	Arnês	MT	Ċinga tas-sigurtà
IT	Imbracatura	AR	
NL	Harnas	FA	طاقم الشد
PL	Szelki		سیدستم مهار
CS	Popruh	YUE	安全帶
SK	Popruh	CMN	安全帶
SL	Varnostni pas	JA	安全ベルト
HR	Sustav vezivanja	KO	하네스
HU	Biztonsági öv	BG	Сбруя
SE	Sele	SR	Sistem vezivanja
NO	Beltesystem	MS	Abah-abah
FI	Vyöjärjestelmä	HI	कबच
DA	Selesystem	TH	ระบบสายรัด
ET	Turvarihmad	SQ	Pajimet
LV	Drošības josta	BS	Sistem vezivanja
LT	Diržai	ME	Sistem vezivanja
RU	Ремни безопасности	MK	Сигурносен каиш
UK	Ремінь	HY	Ամրապսոսի
		VI	Dây an toàn



 = 32

EN	Bumper bar	TR	Tampon çubuğu
DE	Schutzbügel	EL	Μπάρα διάταξης προστασίας
ES	Barra de seguridad	RO	Bară de protecție
FR	Barre de protection	IS	Þverbítí
PT	Barra de segurança	MT	Strixxa tal-bumper
IT	Barra paraurti	AR	عارضة ممتص الصدمات
NL	Veiligheidsbeugel	FA	میلله ضربیهگیر
PL	Pałak zabezpieczający	YUE	保險杠
CS	Dětské madlo	CMN	保險杠
SK	Detská rúčka	JA	バンパーバー
SL	Varnostni lok	KO	범퍼 바
HR	Štitnik	BG	Броня
HU	Karfa	SR	Štitnik
SE	Stötfångare	MS	Bar bumper
NO	Fender	HI	बम्पर बार
FI	Suojakaari	TH	แถบกันชน
DA	Sikkerhedsbøjle	SQ	Shufra e parakolpit
ET	Turvakaar	BS	Štitnik
LV	Aizsargloks	ME	Štitnik
LT	Amortizatoriaus strypas	MK	Одбојник
RU	Поручень	HY	Թափարգել
UK	Обмежувальний поручень	VI	Thanh chống va đập



 = 31

EN	Seat direction	TR	Koltuk yönü
DE	Sitzrichtung	EL	Κατεύθυνση καθίσματος
ES	Dirección de la silla	RO	Direcție scaun
FR	Sens du siège	IS	Sættisstefna
PT	Orientação do assento	MT	Direzżjoni tas-sit
IT	Direzione di seduta	AR	اتجاه المقعد
NL	Zitrichting	FA	جهت صندلی
PL	Kierunek siedzenia	YUE	座椅方向
CS	Směr sedadla	CMN	座椅方向
SK	Smer sedadla	JA	シートの方向
SL	Smer sedeža	KO	좌석 방향
HR	Smjer sjedala	BG	Посока на седалката
HU	Ülésirány	SR	Smer sedišta
SE	Sitsriktning	MS	Arah kerusi
NO	Seteretning	HI	सीट दिशा
FI	Istumasuunta	TH	ทิศทางที่นั่ง
DA	Sæderetning	SQ	Drejtimi i ndenjësës
ET	Istme suund	BS	Smjer sjedišta
LV	Sēdekļa virziens	ME	Smjer sjedišta
LT	Kėdutės kryptis	MK	Правец на седиште
RU	Направление сиденья	HY	Նստամտողի ուղղությունը
UK	Напрямок сидіння	VI	Hướng ghế ngồi



= 34

EN Backrest
DE Rückenlehne
ES Respaldo
FR Dossier
PT Encosto de costas
IT Schienale
NL Rugleuning
PL Oparcie
CS Opěradlo
SK Operadlo
SL Naslonjalo
HR Naslon
HU Háttámla
SE Ryggstöd
NO Rygglene
FI Selkänoja
DA Ryglæn
ET Seljatugi
LV Atzveltne
LT Nugaras atlošas
RU Спинка
UK Спинка

TR Arkalık
EL Πλάτη
RO Spătar
IS Bak
MT Serħ id-dahar
AR مسند الظهر
FA پشتی
YUE 靠背
CMN 靠背
JA 背もたれ
KO 등받이
BG Облегалка
SR Naslon
MS Penyangdar belakang
HI बैकरेस्ट
TH พนักพิง
SQ Mbështetësja e shpinës
BS Naslon
ME Naslon
MK Наслон за грб
HY Թիկնակ
VI Phần tựa lưng



= 33

EN Legrest
DE Beinstütze
ES Reposapiés
FR Repose-pieds
PT Apoio de pernas
IT Poggiagambe
NL Beensteun
PL Podnózek
CS Opěrka nohou
SK Opierka nôh
SL Naslon za noge
HR Naslon za noge
HU Lábtartó
SE Benstöd
NO Benstøtte
FI Jalkatuki
DA Benstøtte
ET Jalatugi
LV Kāju balsts
LT Kojų atrama
RU Подставка для ног
UK Опора для ніг

TR Bacak desteği
EL Στήριγμα ποδιών
RO Suport picior
IS Fótahvíla
MT Serħ is-saqajn
AR مسند الساق
FA جاپایی
YUE 腿托
CMN 腿托
JA 足のせ
KO 다리받이
BG Подложка за крака
SR Naslon za noge
MS Tempat letak kaki
HI लेगरेस्ट
TH ที่วางขา
SQ Mbështetësja e këmbëve
BS Naslon za noge
ME Naslon za noge
MK Наслон за нозе
HY Ուղեքրի հենման կտն
VI Phần tựa chân



EN	Sun canopy	TR	Güneş başlığı
DE	Sonnenverdeck	EL	Κουκούλα για τον ήλιο
ES	Capota para el sol	RO	Copertină
FR	Pare-soleil	IS	Sólartjald
PT	Capota solar	MT	Kopertura mix-xemx
IT	Parasole	AR	مظلة الشمس
NL	Zonnekap	FA	سایبان
PL	Oslona	YUE	遮陽蓬
CS	przeciwsłoneczna	CMN	遮阳蓬
SK	Stříška proti slunci	JA	日よけカバー
SL	Senčnik za zaščito pred soncem	KO	선 캐노피
HR	Tenda za sunce	BG	Тента
HU	Kupola	SR	Tenda za sunce
SE	Solsufflett	MS	Kanopi matahari
NO	Solskjerm	HI	धूप छतरी
FI	Aurinkokatos	TH	หลังคาบังแดด
DA	Solkaleche	SQ	Strea për diellin
ET	Päikesevari	BS	Tenda za sunce
LV	Saules aizsegs	ME	Tenda za sunce
LT	Stogelis nuo saulės	MK	Стреа за сонце
RU	Солнцезащитный козырек	HY	Արևապաշտպան ծածկ
UK	Тент від сонця	VI	Mái che nắng



EN	Removing the fabric	TR	Kılıfı çıkarma
DE	Entfernen des Bezuges	EL	Αφαίρεση του υφάσματος
ES	Quitar la tela	RO	Îndepărtarea țesăturii
FR	Retrait du tissu	IS	Fjarlægja efni
PT	Remover o tecido	MT	Tneħħija tad-drapp
IT	Rimozione del tessuto	AR	فك القماش
NL	De stof verwijderen	FA	برداشتن پارچه
PL	Zdejmowanie pokrycia	YUE	拆除罩布
CS	Odstranění látky	CMN	拆除罩布
SK	Odstránenie látky	JA	カバーの取り外し
SL	Odstranjevanje blaga	KO	페브릭 제거
HR	Uklanjanje tkanine	BG	Демонтиране на плата
HU	Huzat eltávolítása	SR	Uklanjanje tkanine
SE	Ta bort tyget	MS	Menanggalkan fabrik
NO	Fjerne stoffet	HI	कपड़ा हटाना
FI	Kankaan poisto	TH	การถอดผ้า
DA	Fjernelse af stoffet	SQ	Heqja e copës
ET	Kanga eemaldamine	BS	Uklanjanje tkanine
LV	Pārklājuma atvienošana	ME	Uklanjanje tkanine
LT	Audinio nuėmimas	MK	Отстранување на навлаката
RU	Снятие ткани	HY	Գործվածքը հանելը
UK	Зняття матерії	VI	Tháo phần vải bọc

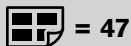

EN	Rain cover	TR	Yağmurluk
DE	Regenverdeck	EL	Καλύπτρα βροχής
ES	Funda para la lluvia	RO	Prelată de ploaie
FR	Housse de pluie	IS	Regn yfirbreiðsla
PT	Capa de chuva	MT	Għata mix-xita
IT	Parapioggia	AR	غطاء المطر
NL	Regenhoes	FA	روکش باران
PL	Oslona od deszczu	YUE	防雨罩
CS	Pláštěnka	CMN	防雨罩
SK	Kryt proti dažďu	JA	雨よけ
SL	Dežna prevleka	KO	레인커버
HR	Pokrivač za kišu	BG	Дъждобран
HU	Esővédő	SR	Pokrivač za kišu
SE	Regnskydd	MS	Pelindung hujan
NO	Kalesje	HI	रेन कवर
FI	Sadesuoja	TH	ผ้าคลุมกันฝน
DA	Regnslag	SQ	Mbulesë për shiun
ET	Vihmakate	BS	Pokrivač za kišu
LV	Pretlietus pārvalks	ME	Pokrivač za kišu
LT	Uždangalas nuo lietaus	MK	Прекривка за дожд
RU	Дождевик	HY	Անձրևապաշտպան ծածկ
UK	Дощовик	VI	Tấm che mưa

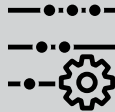
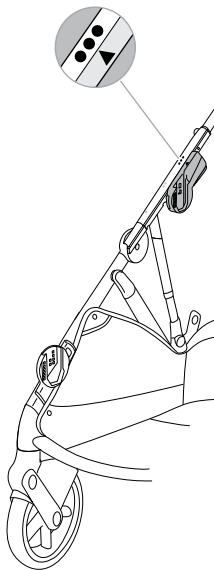
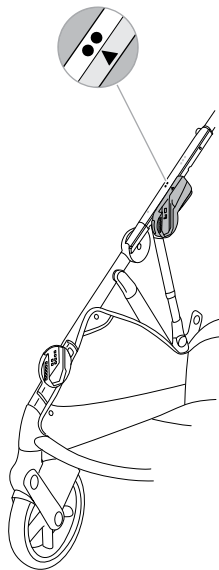
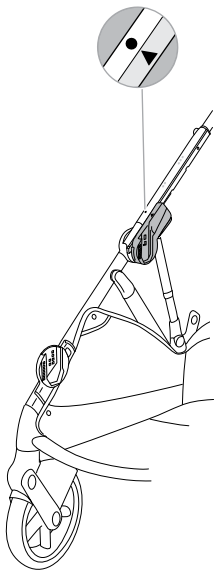



max. 15 kg



max. 22 kg

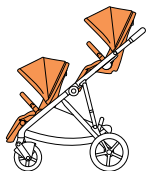

2

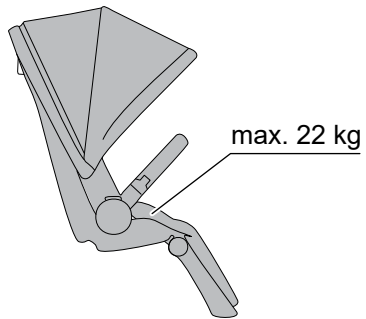

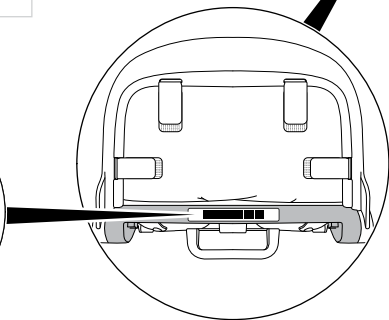
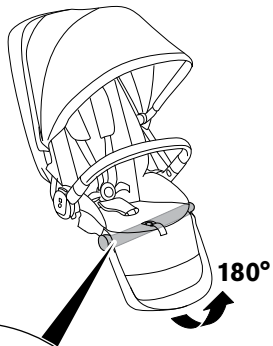

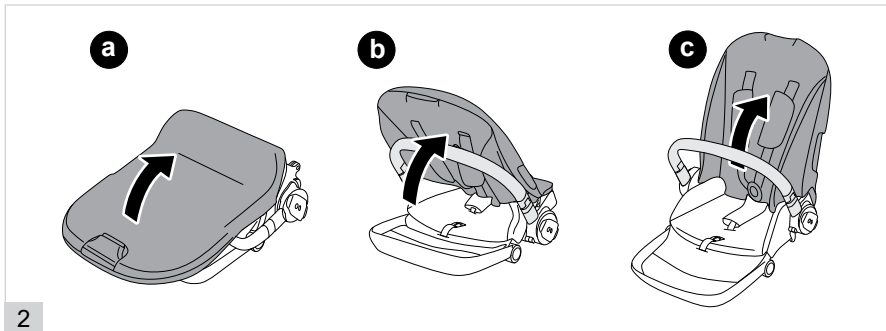
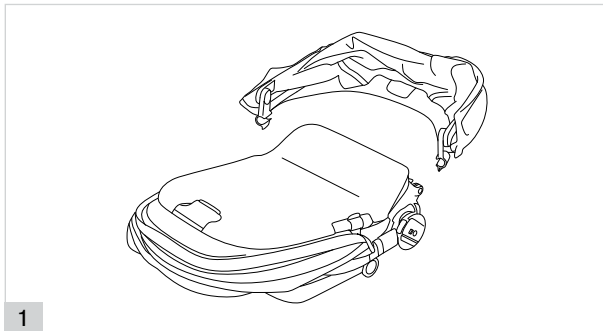

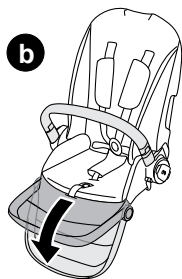
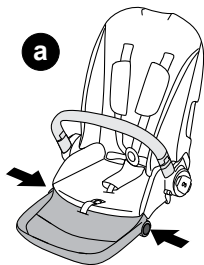

3

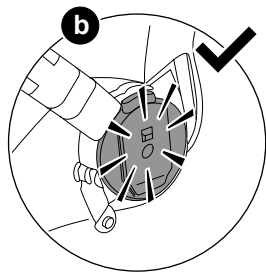
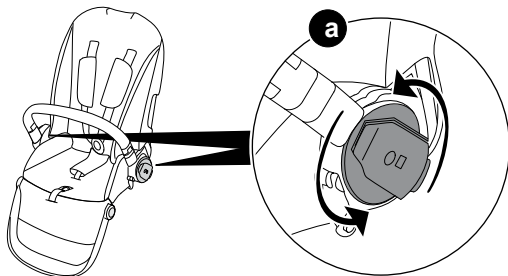

4

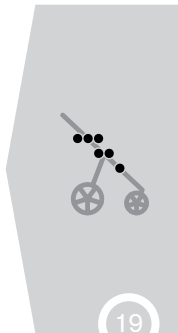
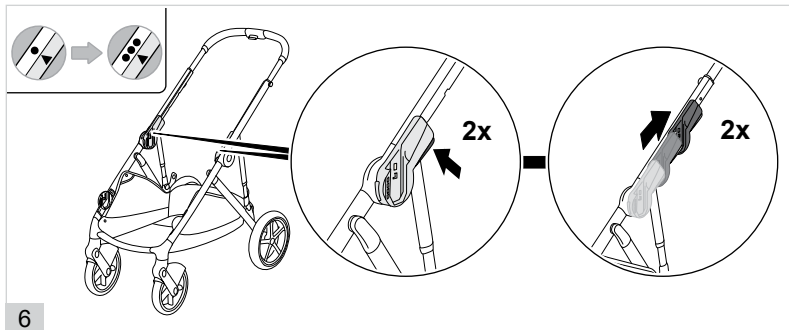
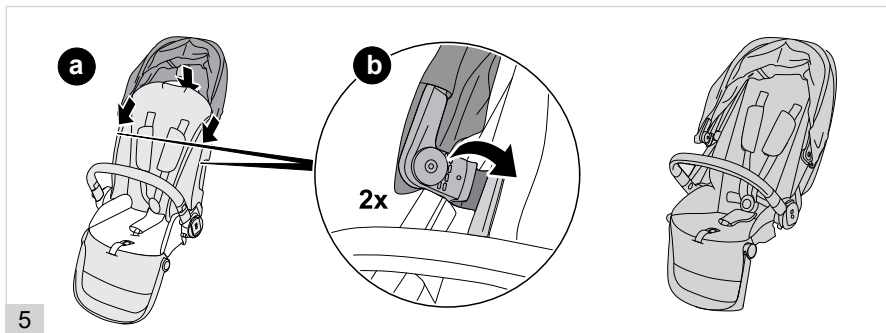

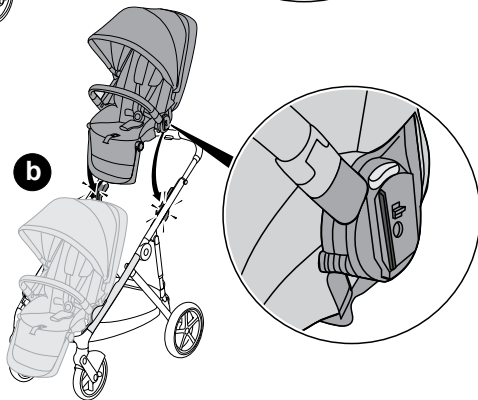
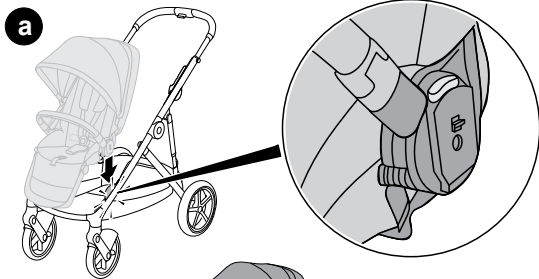

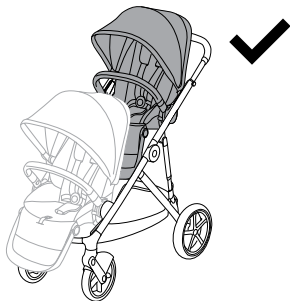

2

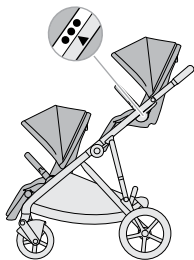
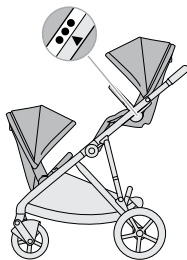
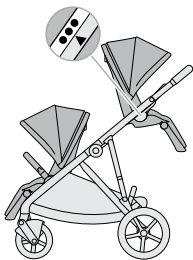
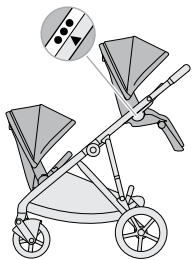

3



1

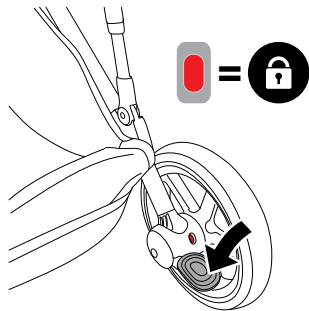

22

2

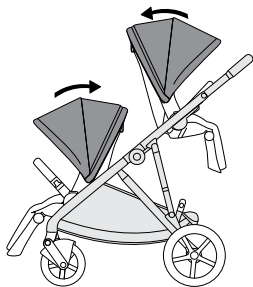

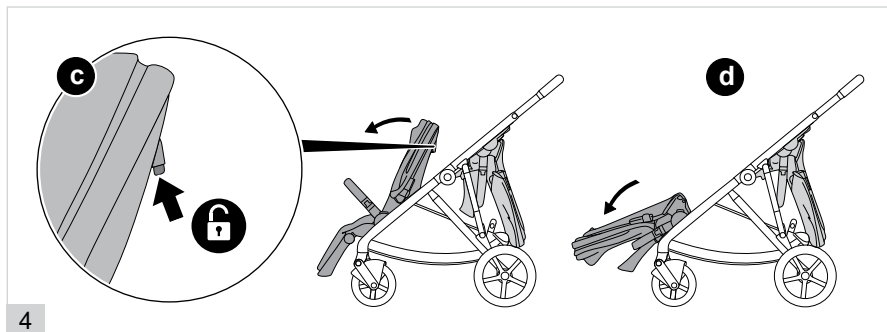
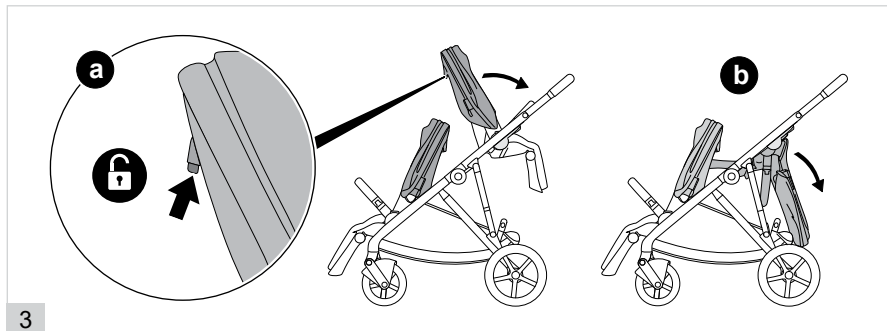

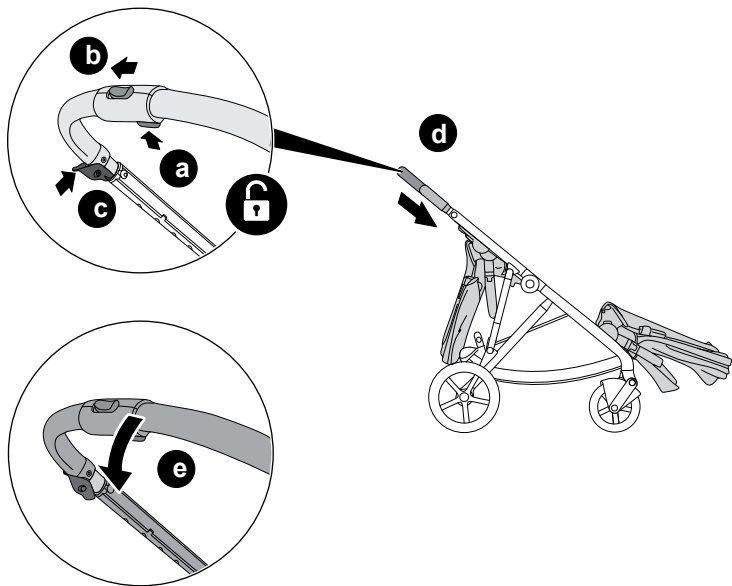

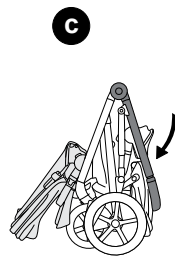
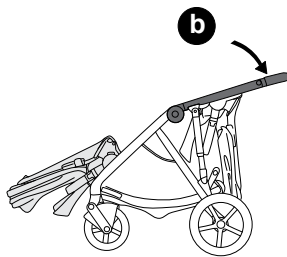
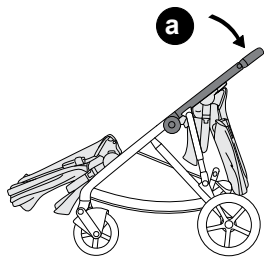

6

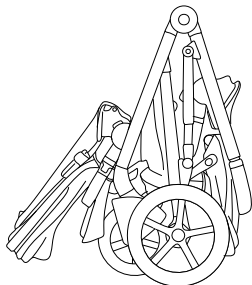

7



1

a

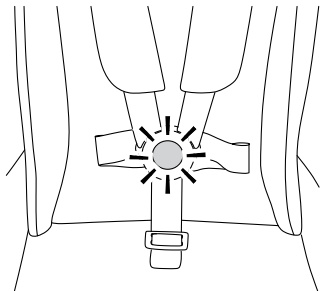

b

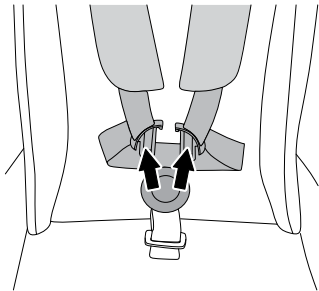

c

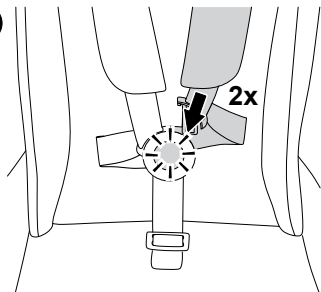

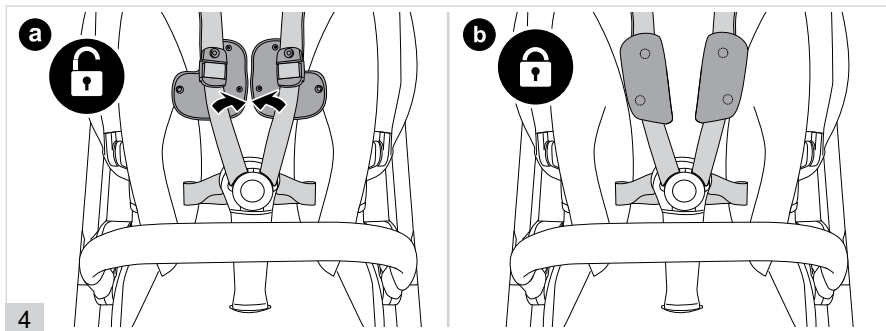
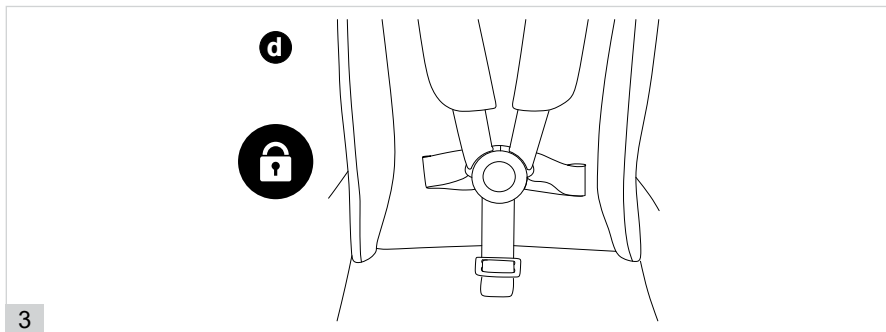

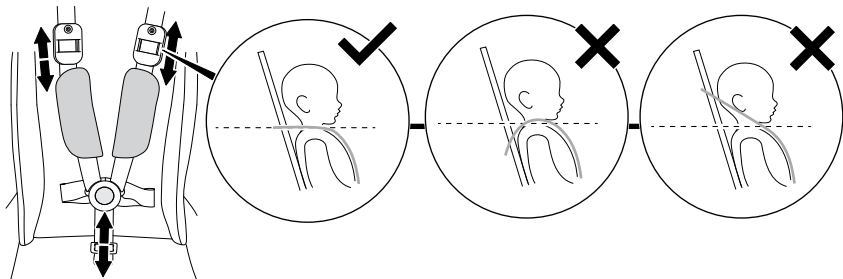

5

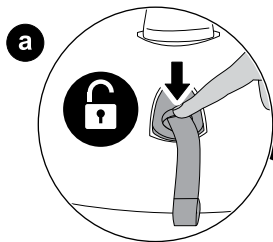

b

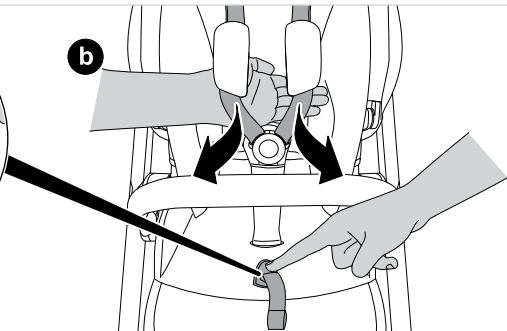

6

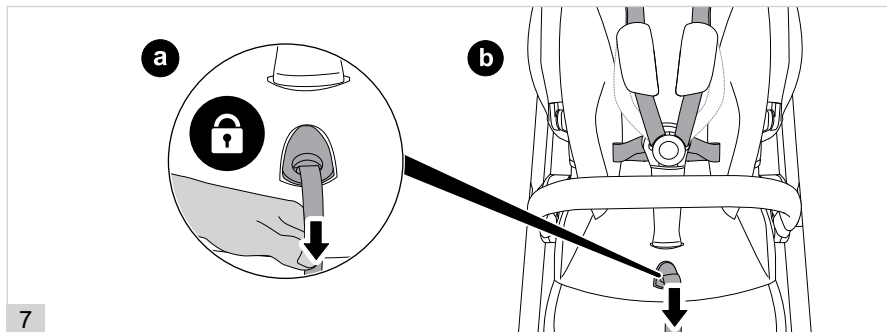

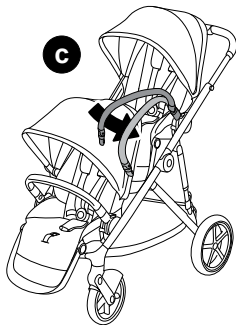
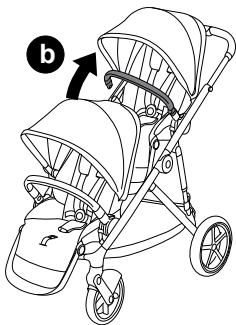
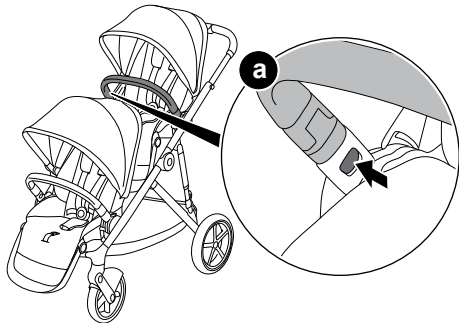

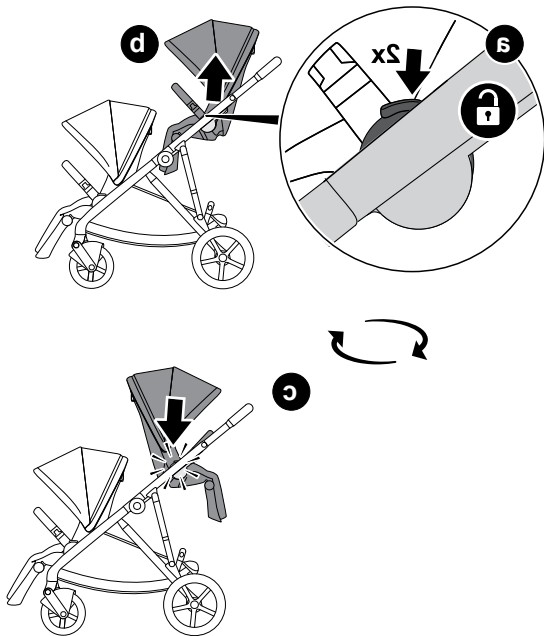

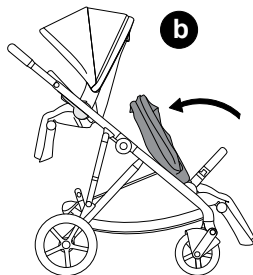
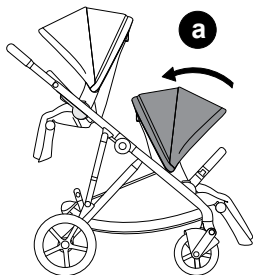

1

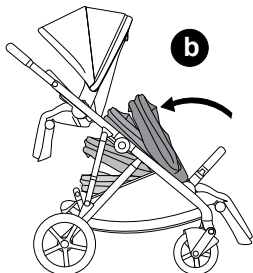
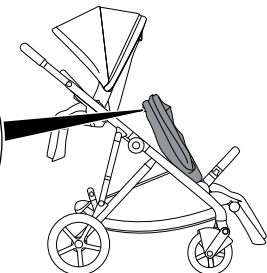
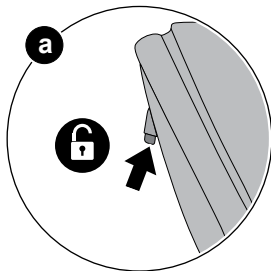

2

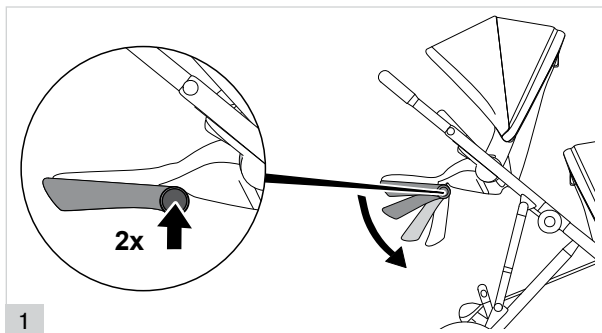
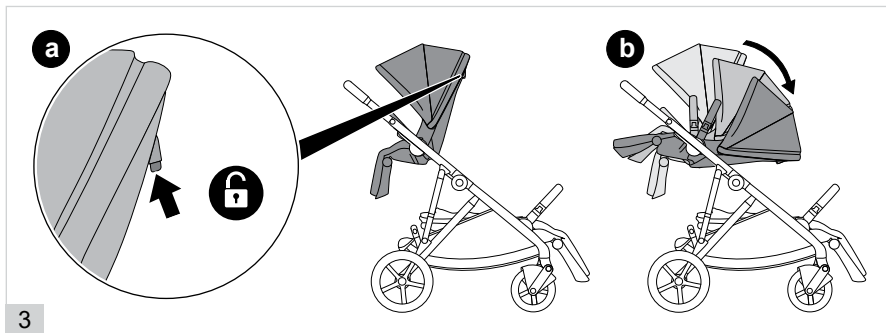

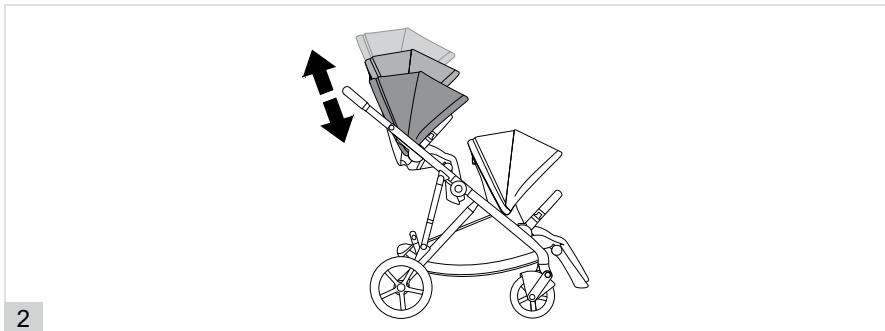
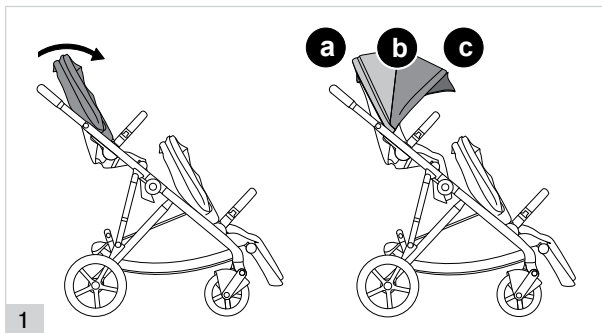

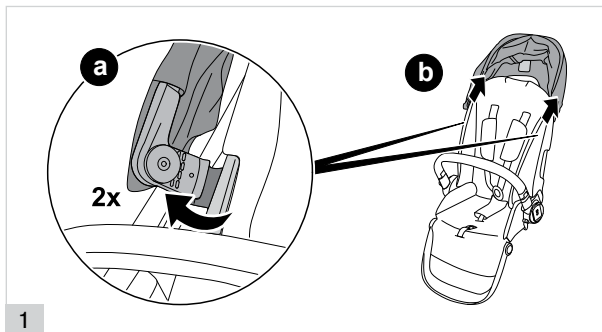

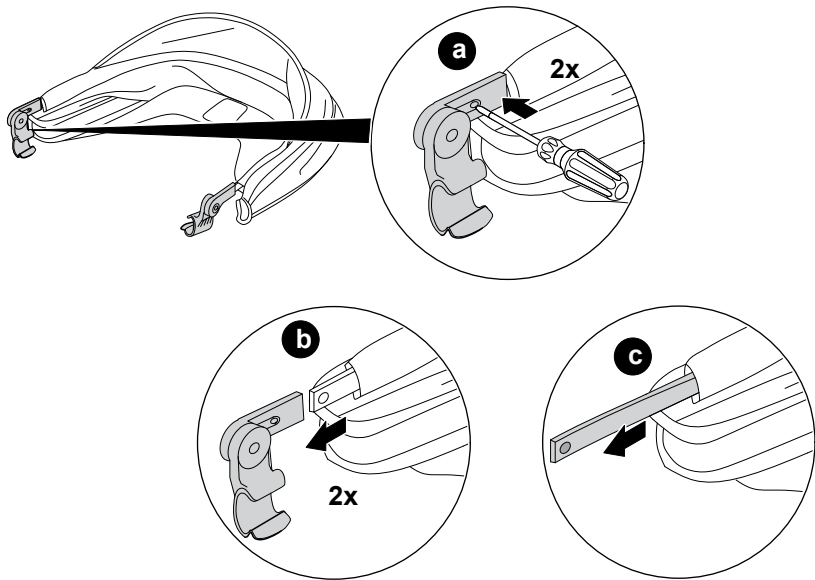



3

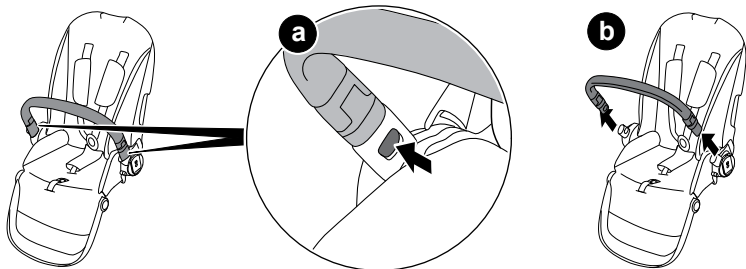

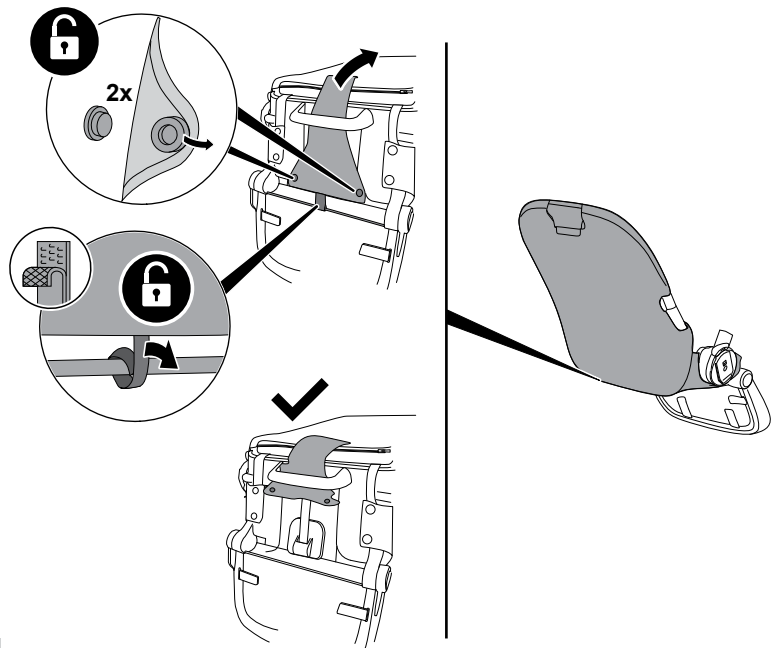

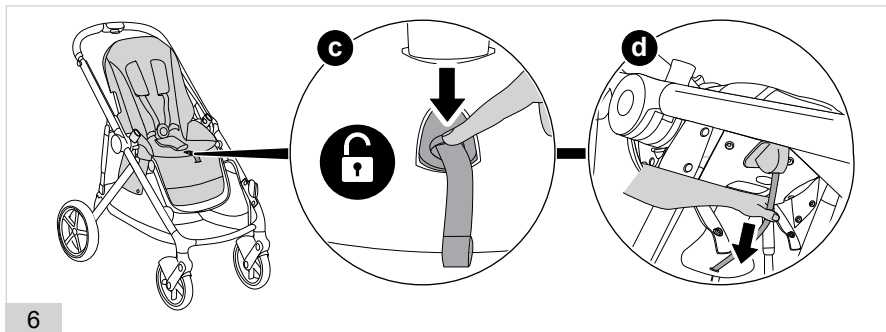
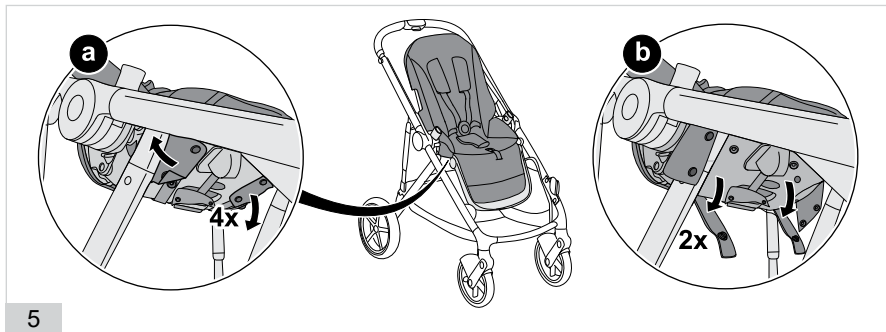

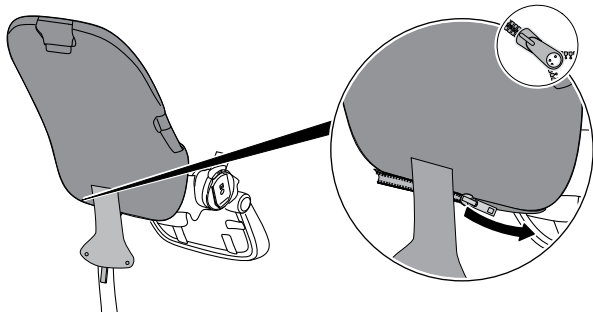

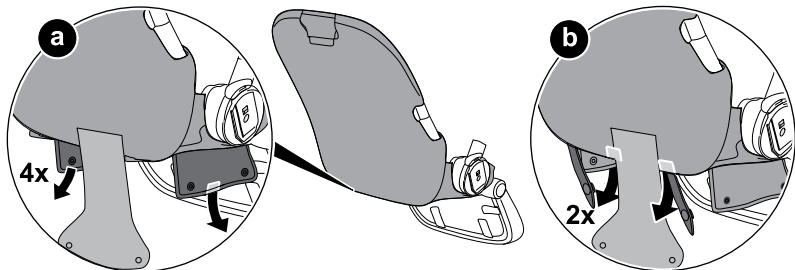

8

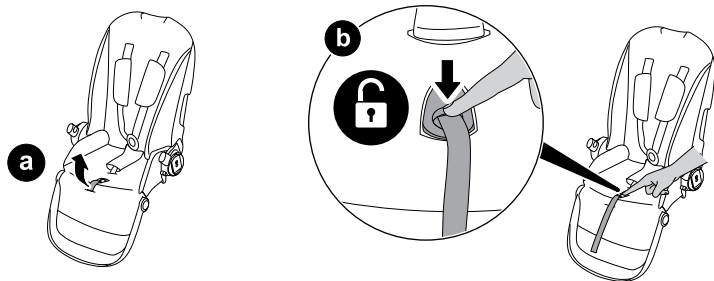

9

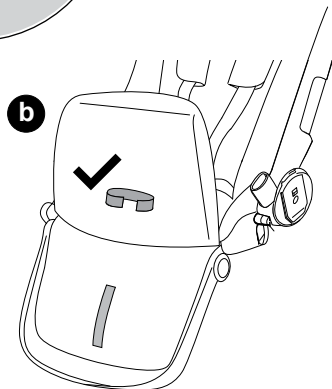
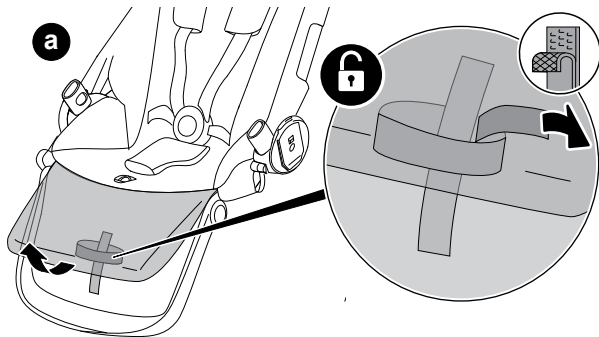

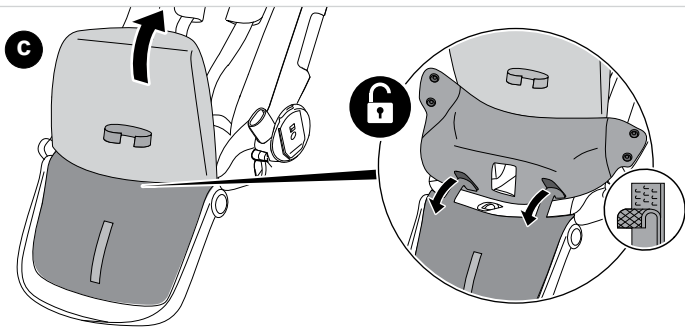

11

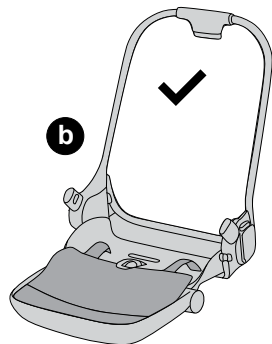
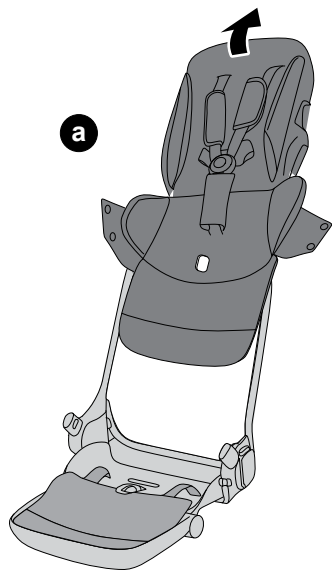

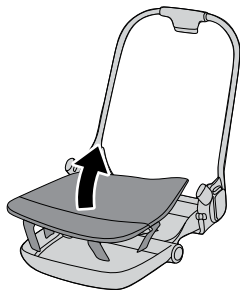
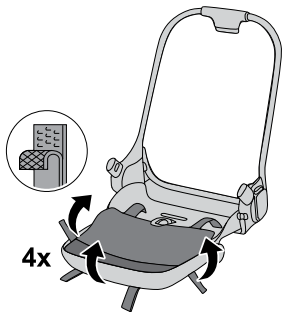

13

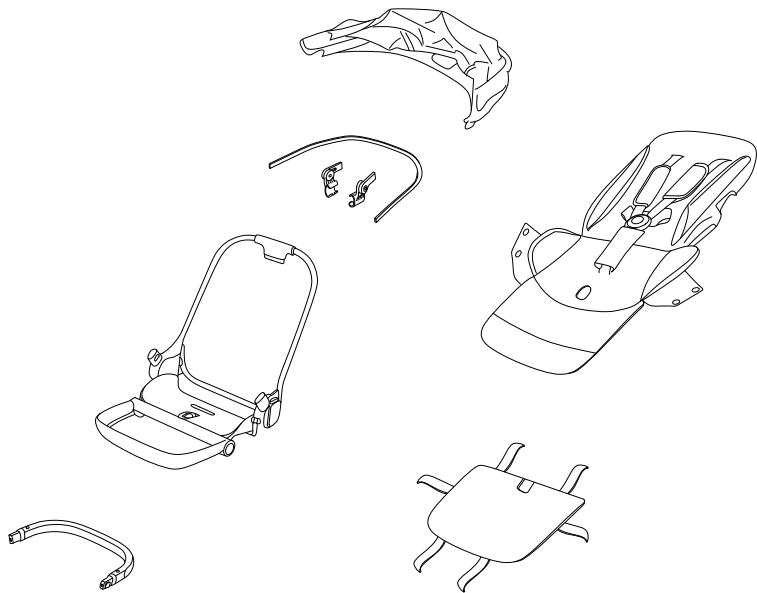

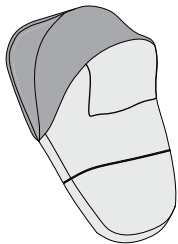

1

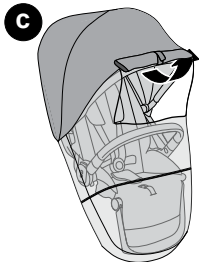
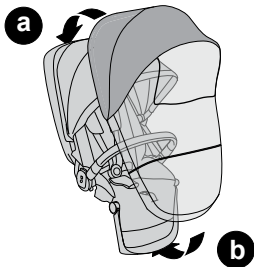

2

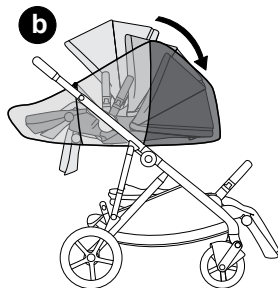
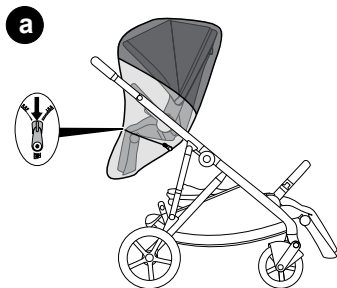

3



CYBEX GmbH
Riedingerstr. 18 | 95448 Bayreuth | Germany
+49 (0) 921-78 511-0 | info@cybex-online.com
www.cybex-online.com



FR
Cet appareil
et ses accessoires
se recyclent

À DÉPOSER
EN MAGASIN

À DÉPOSER
EN DÉCHÈTERIE

OU



Points de collecte sur www.quefairedemesdechets.fr